

1 Steve W. Berman (*Pro Hac Vice*)
Jeff D. Friedman (173886)
2 Shana Scarlett (217895)
HAGENS BERMAN SOBOL SHAPIRO LLP
3 715 Hearst Avenue, Suite 202
Berkeley, CA 94710
4 Telephone: (510) 725-3000
Facsimile: (510) 725-3001
5 steve@hbsslaw.com

6 Elizabeth J. Cabraser (083151)
Richard M. Heimann (63607)
7 Eric B. Fastiff (182260)
LIEFF CABRASER HEIMANN & BERNSTEIN, LLP
8 275 Battery Street, 29th Floor
San Francisco, CA 94111-3339
9 Telephone: (415) 956-1000
Facsimile: (415) 956-1008
10 ecabraser@lchb.com

11 Joseph W. Cotchett (36324)
Steven N. Williams (175489)
12 Demetrius X. Lambrinos (246027)
Joyce Chang (300780)
13 COTCHETT, PITRE & McCARTHY, LLP
840 Malcolm Road
14 Burlingame, CA 94010
Telephone: (650) 697-6000
15 Facsimile: (650) 697-0577
jcotchett@cpmlegal.com

16 *Indirect Purchaser Plaintiffs*
17 *Interim Co-Lead Class Counsel*
[Additional Counsel Listed on Signature Page]

18 UNITED STATES DISTRICT COURT
19 NORTHERN DISTRICT OF CALIFORNIA
20 OAKLAND DIVISION

21
22 IN RE LITHIUM ION BATTERIES
ANTITRUST LITIGATION

Case No. 13-MD-02420 YGR (DMR)

23 CLASS ACTION

24 This Documents Relates to:
25 ALL INDIRECT PURCHASER ACTIONS

INDIRECT PURCHASER PLAINTIFFS'
FOURTH CONSOLIDATED AMENDED
CLASS ACTION COMPLAINT

26 DEMAND FOR JURY TRIAL
27
28

TABLE OF CONTENTS

1
2
3
4
5
6
7
8
9
10
11
12
13
14
15
16
17
18
19
20
21
22
23
24
25
26
27
28

	<u>Page</u>
I. INTRODUCTION	1
II. DESCRIPTION OF LITHIUM ION BATTERIES	7
A. Background of Batteries	7
B. Lithium Ion Batteries.....	9
1. Properties and types of LIBs.	9
2. LIBs are commodity products.	13
III. DEFENDANTS CONSPIRED TO RAISE AND STABILIZE LITHIUM ION BATTERY PRICES	15
A. Summary and Examples of Defendants’ Overt Acts in Furtherance of Their Conspiracy	15
1. Defendants’ collusive activities began at least as early as 2000 and continued throughout the Class Period.....	16
2. Examples of Defendants’ Continued Conspiratorial Meetings and Communications in 2005.....	39
3. Examples of Defendants’ Continued Conspiratorial Meetings and Communications in 2006.....	43
4. Examples of Defendants’ Continued Conspiratorial Meetings and Communications in 2007.....	45
5. Examples of Defendants’ Continued Conspiratorial Meetings and Communications in 2008.....	49
6. Examples of Defendants’ Continued Conspiratorial Meetings and Communications in 2009.....	57
7. Examples of Defendants’ Continued Conspiratorial Meetings and Communications in 2010.....	58
8. Examples of Defendants’ Continued Conspiratorial Meetings and Communications in 2011.....	61
B. The U.S. Subsidiary Defendants Directly Participated in the Conspiracy	61
1. LGCAI’s Participation in the Conspiracy	62
2. SDIA’s Participation in the Conspiracy	68
3. Sanyo North America’s Participation in the Conspiracy	71

1	a.	Sanyo North America’s Direct Communications Regarding the Conspiracy	71
2			
3	b.	Sanyo North America Employed Foreign Executives Who Participated in Conspiratorial Conduct	73
4	c.	Sanyo Japan Directed Sanyo North America Pricing and Supply Decisions	74
5			
6	4.	Panasonic North America’s Participation in the Conspiracy	75
7	a.	Panasonic North America’s Direct Communications Regarding the Conspiracy	75
8	5.	Sony North America’s Participation in the Conspiracy	77
9	a.	Sony North America’s Direct Communications Regarding the Conspiracy	77
10			
11	b.	Sony North America Employed Foreign Executives Who Participated in Conspiratorial Conduct	77
12	c.	Sony Japan Directed Sony North America Pricing and Supply Decisions	78
13			
14	6.	Maxell Corp. of America’s Participation in the Conspiracy	79
15	a.	Maxell Corp. of America’s Direct Communications Regarding the Conspiracy	79
16	b.	Hitachi Maxell, Ltd. Directed Maxell Corp. of America’s Pricing and Supply Decisions.....	80
17			
18	C.	Economic Evidence Shows Defendants’ Conspiracy Succeeded	80
19	1.	Defendants’ Conspiracy to Raise LIB Prices Broke Apart Soon After They Received DOJ Subpoenas	80
20	2.	Prices for Lithium Ion Batteries During the Class Period Defied Industry Expectations	83
21			
22	3.	The Defendants’ Pricing and Production Levels in Response to the Global Economic Crisis in 2008 Further Supports the Existence of the Conspiracy	89
23			
24	D.	The Structure and Characteristics of the Lithium Ion Battery Market Plausibly Support the Alleged Conspiracy.....	90
25	1.	The Lithium Ion Batteries Market Has High Barriers to Entry	90
26	2.	The Demand For Lithium Ion Batteries Is Inelastic.....	95
27	3.	The Market For Lithium Ion Batteries Is Highly Concentrated.....	95
28			

1 4. Trade Associations, Industry Conferences and Other Common Forums
2 Available to Facilitate Collusion 97
3 a. Battery Association of Japan 98
4 b. Korean Battery Trade Associations 99
5 c. Other Trade Associations 101
6 E. Government Investigations into a Lithium Ion Batteries Cartel 102
7 1. The Criminal Guilty Pleas of Sanyo Electric Co., Ltd. and LG Chem,
8 Ltd..... 104
9 a. Sanyo Electric Co. Ltd.’s Criminal Guilty Plea 104
10 b. LG Chem Ltd.’s Guilty Plea Agreement 106
11 F. Defendants Have a History of Conspiring to Fix Prices for Critical
12 Components of Consumer Electronics 108
13 IV. THE ROLE OF THE PACKER COMPANIES IN THE INDUSTRY 111
14 A. Simplo Technology Co., Ltd. 111
15 B. Celxpert 113
16 C. Dynapack 114
17 V. MANNER AND MEANS OF THE CONSPIRACY 115
18 VI. THE INFLATED PRICES OF LITHIUM ION BATTERIES WERE PASSED
19 THROUGH TO CONSUMERS 116
20 VII. ANTITRUST INJURY 119
21 VIII. PLAINTIFFS’ CLAIMS ARE NOT BARRED BY THE STATUTE OF
22 LIMITATIONS 120
23 A. The Statute of Limitations Did Not Begin to Run Because Plaintiffs Did Not
24 and Could Not Discover Their Claims 120
25 B. Fraudulent Concealment Tolled the Statute of Limitations 126
26 IX. TRADE AND COMMERCE AFFECTED BY DEFENDANTS’ CONSPIRACY 127
27 A. Defendants’ Conduct Involved Import Trade or Import Commerce 128
28 B. Defendants’ Conduct Had a Direct, Substantial, and Reasonably Foreseeable
 Effect on U.S. Domestic and Import Trade or Commerce That Gave Rise to
 Plaintiffs’ Antitrust Claims 129
 X. JURISDICTION AND VENUE 135

1 XI. PARTIES..... 137

2 A. Plaintiffs 137

3 B. Governmental Plaintiffs..... 141

4 C. Defendants 142

5 D. Agents and Co-Conspirators..... 148

6 XII. CLASS ACTION ALLEGATIONS..... 149

7 XIII. VIOLATIONS ALLEGED 157

8 FIRST CLAIM FOR RELIEF (VIOLATIONS OF SHERMAN ACT, 15 U.S.C. § 1) (On

9 Behalf of All Plaintiffs against All Defendants) 157

10 SECOND CLAIM FOR RELIEF (VIOLATIONS OF THE CARTWRIGHT ACT, CAL.

11 BUS. & PROF. CODE §§ 16720, *et seq.*) (On Behalf of All Plaintiffs against All

12 Defendants)..... 158

13 THIRD CLAIM FOR RELIEF VIOLATIONS OF CALIFORNIA’S UNFAIR

14 COMPETITION LAW CAL. BUS. & PROF. CODE §§ 17200, *et seq.*) (On Behalf of All

15 Plaintiffs against All Defendants) 162

16 FOURTH CLAIM FOR RELIEF VIOLATION OF STATE ANTITRUST AND

17 RESTRAINT OF TRADE LAWS (On Behalf of All Plaintiffs against All

18 Defendants)..... 163

19 FIFTH CLAIM FOR RELIEF VIOLATION OF STATE CONSUMER PROTECTION

20 AND UNFAIR COMPETITION LAWS) (On Behalf of All Plaintiffs against All

21 Defendants)..... 174

22 PRAYER FOR RELIEF 180

23 DEMAND FOR JURY TRIAL 181

24

25

26

27

28

1 The Indirect Purchaser Plaintiffs listed in paragraphs 393-415 below (“Plaintiffs”) bring this
2 action on their own behalf and as a putative class action on behalf of all others similarly situated in
3 the United States. Plaintiffs, by and through their attorneys, based on their individual experiences,
4 the independent investigation of counsel and consultants, and information and belief, allege as
5 follows based upon information known to date:

6 **I. INTRODUCTION**

7 1. Defendants are the world’s largest manufacturers of Lithium Ion Batteries (defined
8 below), and include multinational corporations Samsung, LG, Sanyo, Sony, Panasonic, NEC,
9 Toshiba and Hitachi. “Lithium Ion Batteries,” or “LIBs,” are battery cells which are rechargeable
10 and which utilize lithium ion technology. Lithium Ion Batteries are sometimes also referred to as
11 secondary batteries. Lithium Ion Batteries power virtually every laptop computer, cellphone,
12 smartphone, digital music player (*e.g.*, iPods), tablet device (*e.g.*, iPads), digital camera and
13 camcorder, and cordless power tool used today. Defendants control a substantial majority of the
14 \$16 billion annual market for Lithium Ion Batteries, dominating sales to original equipment
15 manufacturers (“OEMs”) such as Dell, HP, Apple and virtually every other household name
16 manufacturer of consumer electronics.

17 2. Defendants engaged in a long-running conspiracy over more than a decade, the object
18 of which was to unlawfully fix, raise and stabilize prices for cylindrical Lithium Ion Batteries in
19 violation of federal and state antitrust laws. Defendants’ cartelization of the worldwide market is
20 revealed in Defendants’ secret internal materials and records, some of which were recently produced
21 to Plaintiffs.

22 3. Defendants include two convicted felons – Sanyo Electric Co., Ltd. and LG Chem,
23 Ltd. – both of which recently pled guilty to the criminal price-fixing of Lithium Ion Batteries.

24 4. Plaintiffs and the proposed Classes consist of persons and entities who (1) indirectly
25 purchased a stand-alone cylindrical Lithium Ion Battery manufactured by a Defendant, or (2) a
26 Lithium Ion Battery Product containing a cylindrical Lithium Ion Battery manufactured by a
27 Defendant, during the period from and including January 1, 2000 through May 31, 2011 (the “Class
28

1 Period”).¹ The products containing cylindrical Lithium Ion Batteries and for which Plaintiffs and the
2 Classes seek damages are portable computers (laptops, notebooks, or netbook), power tools, and
3 camcorders/digital video cameras, as well as replacement batteries for each of the aforementioned
4 products (collectively “Lithium Ion Battery Products”). Due to Defendants’ collusion, Plaintiffs and
5 Class members were damaged by paying artificially inflated prices for Lithium Ion Battery Products.

6 5. As *The Economist* reported in 2002, “Lithium-ion batteries are the foot-soldiers of the
7 digital revolution. They power telephones, music players, digital cameras and laptops. They are
8 amazingly small and light, and can store more energy in less space than any other type of
9 rechargeable battery.”² The report continued that “[w]ithout the lithium-ion battery, introduced a
10 decade ago, portable gadgets – from mobile phones and video cameras to laptops and palmtops –
11 would have remained brick-like objects best left on the desk or at home.”

12 6. Defendants’ unlawful conduct is a textbook price-fixing cartel. That is, a small,
13 concentrated group of Lithium Ion Battery manufacturers, producing commoditized products, sought
14 to artificially increase prices by agreeing to restrain competition among themselves. Defendants’
15 agreement to fix and stabilize Lithium Ion Battery prices was accomplished through several means.
16 The means included restricting output and supply, agreeing on prices or price targets (including price
17 increases, and limiting price reductions), using common formulas tied to material costs to set
18 industry prices, and price-floors, below which Defendants would not agree to sell LIBs. While the
19 manner, means, and impact varied over time, the cartel’s common goal during the conspiracy was to
20 artificially raise the prices of Lithium Ion Batteries above the competitive level. And indeed,
21 Defendants were successful, to the detriment of Plaintiffs and Class members.

22 7. No later than 2000, Defendants were engaging in collusive discussions – including
23 face-to-face meetings and telephone conversations – for the purpose of providing confidential,
24 highly-sensitive information to each other concerning their manufacture and sale of Lithium Ion
25 Batteries. The collusive discussions and in-person meetings occurred among Defendants sometimes
26

27 ² *Hooked on Lithium*, *The Economist*, <http://www.economist.com/node/1176209> (last visited
28 June 10, 2013).

1 on a monthly basis, and even more frequently at times during the conspiracy. Meetings between
2 these competitors occurred at locations such as restaurants, airports, office buildings, and hotel
3 meeting rooms. During these collusive meetings and discussions, it was understood that Defendants
4 shared a common goal to restrain price competition. Defendants believed cooperation was important
5 to limit price competition. And so in furtherance of their common goal to limit price competition,
6 Defendants communicated to each other highly detailed information about pricing, capacity,
7 utilization, demand, marketing and product development plans.

8 8. The reason that Defendants held these collusive discussions over numerous years to
9 restrain competition was because the market for Lithium Ion Batteries was experiencing pricing
10 pressure based on the increasing commodity nature of Lithium Ion Batteries and new entrants who
11 were willing to lower prices to increase their market share. The competitors quickly concluded that
12 they did not want to wage a price war – and so they colluded instead of competed.

13 9. By engaging in these collusive meetings, and systematically sharing highly-sensitive,
14 competitive information, Defendants sought to, and did, achieve their joint goal of elevating Lithium
15 Ion Battery prices. Many of the Foreign Defendants have recently produced confidential documents
16 detailing some of Defendants’ secret meetings in furtherance of the conspiracy. The documents
17 reflect dozens of face-to-face conspiratorial meetings between Defendants, in which high-level
18 executives with pricing authority discussed and agreed to cooperate to avoid price competition. To
19 achieve their common goal, these senior executives shared confidential pricing, capacity, utilization,
20 demand, marketing, and product development future plans and strategies. Internal emails and other
21 records document Defendants’ conscious commitment to collectively stabilize and raise Lithium Ion
22 Battery prices.

23 10. For example, on October 24, 2002, executives from Samsung and Sanyo GS Soft
24 Energy Co. Ltd. (“GS Soft Energy” or “SGS”), two direct competitors, met at GS Soft Energy
25 Company’s offices in Japan and discussed and agreed they did not want industry price competition
26
27
28

1 because it would hurt them and the other Defendants: “*With price competition only, all will be in*
2 *trouble → have to make the industry Healthy.*”³

3 11. Another collusive meeting in 2004 documented Sony and Samsung’s understanding
4 that price reductions by the competition needed to (and would) stop. Specifically, on June 30, 2004,
5 the following executives from Sony and Samsung, two direct competitors agreed: “*Some Cell*
6 *Makers started price reduction. This is a dangerous situation where cost is increasing while price*
7 *is going down. Sony is not responding with price. If it responds, then the market will be destroyed*
8 *so price reduction must be suppressed.*”

9 12. On July 22, 2005, Samsung executives met with executives from competitor Hitachi
10 Maxell, in Osaka, Japan at the “Ibaraki Market Maxell Factory Internal Conference Room.” The
11 companies agreed that they “*[m]ust cooperate in terms of control over industry.*”

12 13. More examples of Defendants’ meetings to collude include discussions about
13 restraining output to increase prices. For example, in February 2005 meetings, executives from
14 Samsung, Sanyo, Sony, Matsushita, GS Soft Energy (SGS), NEC-Tokin, and Hitachi Maxell,
15 discussed and agreed upon supply restrictions. Samsung’s “Planning Department” wrote internally
16 after these collusive meetings: “*It is the situation of the decline of selling price and oversupply,*
17 *thus, the overall situation of the industry for 2005 is expected to be difficult. [and that Samsung]*
18 *Requested to refrain from adding lines competitively, and each company seems to be willing to*
19 *refrain from adding new lines.*”

20 14. Evidence also demonstrates that in August 2006 competitors Samsung and Sanyo met
21 in Tokyo at a restaurant “near Roppongi.” Defendants memorialized their discussions which
22 included their understanding “*that the 3 companies (Sanyo, SONY, SDI) will lead the market with*
23 *stability with the golden section – okay to compete on technology, but refuse competition based on*
24 *sales price.*”

25 15. Documents show Defendants understood their actions violated international antitrust
26 laws – and yet they cavalierly dismissed these concerns. For example, in November 2007, an LG
27

28 ³ All emphasis in these documents have been added by Plaintiffs, unless otherwise indicated.

1 executive sent an internal email regarding a recent conversation with LG’s direct competitor
2 Samsung (referred to as “S Company”). “In regards to an S Company meeting, S Company informed
3 me that it is uncomfortable attending a meeting due to company internal issues and that it would
4 contact us soon.” Another LG executive explained that Samsung seemed to be under “*special*
5 *investigation by the Prosecutors’ Office. As an external explanation, they are saying that they are*
6 *restraining from contacts with other companies due to the Fair Trade Commission’s*
7 *investigation.*” LG characterized Samsung’s statement as “somewhat of a *lame excuse.*” LG then
8 indicated that despite the investigation, “*During a phone conversation with JGL [a Samsung senior*
9 *executive], we agreed to make a contact in any way next year.*”

10 16. Samsung shared LG’s view that governmental antitrust investigations were, as LG put
11 it, a “lame excuse” and should not impede the price-fixing conspiracy. After this discussion in
12 December 2007 between LG and Samsung, for example, with respect to pricing of Lithium Ion
13 Batteries to go into Apple’s iPads, on December 1, 2010, LG executive Young Wook Chun reported
14 via email to numerous LG executives his discussions with Samsung Vice President Yo Ahn Oh,
15 stating: “*We said that we would raise the price at least by 10% from the existing price, and they*
16 *also promised to commit.*”

17 17. Frequently, Defendants’ collusive meetings occurred between two Defendants at one
18 time. The same Defendants would then hold collusive meetings with other Defendants as well within
19 days of each other. Or, the Defendants would simply pass along the meeting notes to their co-
20 conspirators. It was understood based on the substance of the discussions in these meetings that
21 Defendants had been having collusive discussions with other Defendants for the same purpose of
22 collectively raising Lithium Ion Battery prices.

23 18. Defendants’ consciousness of guilt is also shown by their use of concealment
24 measures, such as coded emails, covert meetings, and instructions to destroy evidence of their
25 conspiracy. Documents reflect a near-constant use of code names such as “S Company,” “Osaka
26 Company,” and descriptions such as “information obtained regarding the grand mansion S across the
27 sea. . . .” (referring to Japanese conspirator Sanyo). Numerous emails between conspirators
28

1 instructed that the recipient should “delete . . . upon reading” and delete “immediately” and “as soon
2 as possible” – evidencing an awareness of their illegal activities.

3 19. Economic facts further support the existence of Defendants’ conspiracy to raise
4 Lithium Ion Battery prices. For example, very soon after the DOJ served subpoenas on some of the
5 Defendants in mid-2011 relating to potential criminal antitrust violations in the market for Lithium
6 Ion Batteries, Defendants’ prices rapidly dropped at a rate only seen during the prior decade in the
7 global recession.

8 20. In order for Defendants’ conspiracy to succeed worldwide in elevating prices, the
9 Foreign Defendants and U.S. Subsidiary Defendants had to work in concert when targeting the
10 integral U.S. sector of the \$16 billion annual market for Lithium Ion Batteries. The conscious
11 participation of numerous U.S. Subsidiary Defendants in Defendants’ scheme is evidenced by
12 internal discussions. For example, in September 2008, a senior executive from LG in Korea emailed
13 an executive at LG’s U.S. subsidiary in Texas to report on a collusive meeting with competitor
14 Samsung, and that Samsung “*told us to basically move together, and has decided to delay a price*
15 *cut and minimize a decrease level as much as possible.*” Additional specific details regarding the
16 conscious participation of the U.S. Subsidiary Defendants are provided herein in section III.B.

17 21. Defendants’ conspiracy mirrors in many respects their conduct in other price-fixing
18 cases previously brought against them, their parents, or affiliates. These Defendants, their parents,
19 subsidiaries, and/or affiliates have orchestrated some of the largest global price-fixing conspiracies
20 witnessed in the past decade – fixing the prices of key components for consumer electronic goods, in
21 particular computers, televisions, and cellular phones. These entities, and many of their executives,
22 have pleaded guilty to price-fixing dynamic random access memory (“DRAM”) chips, liquid crystal
23 display (“LCD”) screens, optical disk drives (“ODD”), and cathode ray tube (“CRT”) screens. These
24 component part conspiracies – like the conspiracy to fix Lithium Ion Battery prices – all have very
25 similar features, including: (a) a highly concentrated market, controlled by Asian corporations;
26 (b) pricing pressure exerted on the conspirators by large original equipment manufacturers (“OEMs”)
27 seeking to price their products in a competitive consumer electronics market; (c) rapid
28

1 commoditization of new technology; and (d) pricing behavior inconsistent with a competitive
2 market.

3 22. Just like these other criminal conspiracies, Defendants' conspiracy here successfully
4 targeted yet again another key component of consumer electronic goods by collusively setting
5 inflated prices for Lithium Ion Batteries. As a direct result, the prices of Lithium Ion Battery
6 Products, such as those purchased by the Plaintiffs and class members, were inflated by the illegal
7 overcharges being passed-on through the distribution channel to the end consumers.

8 II. DESCRIPTION OF LITHIUM ION BATTERIES

9 A. Background of Batteries

10 23. Batteries are one of the primary sources of energy which power many different
11 machines and devices used every day. There are three different categories of batteries: 1) chemical;
12 2) physical; and 3) biological. Chemical batteries generate electricity through a chemical reaction
13 that occurs inside the battery. The batteries at issue in this case – Lithium Ion Batteries – are within
14 the chemical family of batteries.

15 24. Chemical batteries are generally classified as either “primary” or “secondary.”
16 Primary batteries are disposable batteries that one uses until they are expended, and then they are not
17 reused and are discarded. Secondary batteries are rechargeable. Rechargeable batteries account for
18 roughly 80% of all chemical batteries produced worldwide.

19 25. There are four types of secondary batteries that account for the vast majority of
20 secondary batteries: (1) Lithium Ion Batteries; (2) lead-acid; (3) nickel-cadmium; and (4) nickel-
21 metal hydride. Lithium Ion Batteries are by far the most popular type of rechargeable battery.

22 26. Both Lithium Ion Batteries as well as nickel-metal hydride rechargeable batteries
23 were introduced in or around 1991. Since that time, however, Lithium Ion Batteries have quickly
24 become the most popular type of secondary battery, easily outpacing nickel-metal hydride and
25 nickel-cadmium rechargeable batteries. Figure 1 below compares the growth rates of Lithium Ion
26 Batteries to nickel-metal hydride and nickel-cadmium batteries from 1991-2010:

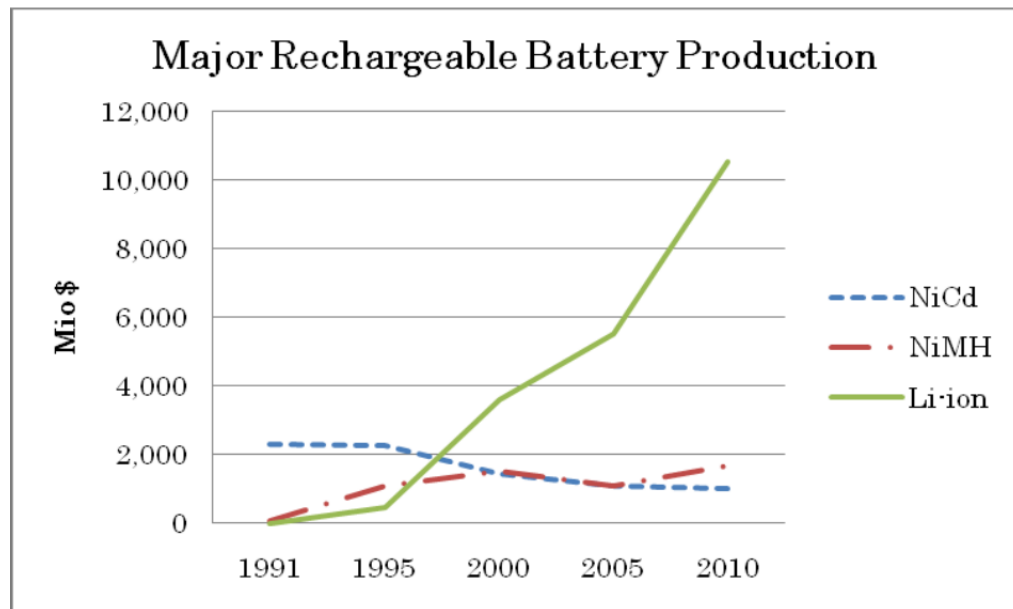
Figure 1: Major Rechargeable Battery Production

27. The European Commission (“EC”), in examining Panasonic’s 2009 acquisition of Sanyo, detailed the distinctiveness of Lithium Ion Batteries. The EC stated the following in its “Article 6(s) Non-Opposition” dated September 29, 2009: “Portable rechargeable batteries come mainly in three principle different chemistries, nickel-cadmium (“NiCd”), nickel-metal hydride (“NiMH”) and Lithium-ion (“Li-ion”), which all have different physical and performance characteristics.”⁴ The EC report rejected Panasonic’s suggestion that nickel-metal hydride and Lithium Ion batteries were a part of the same market:

The market investigation does not support the Parties’ submission. It has shown that both battery types belong to distinct product markets. The production facilities for NiMH batteries and Li-Ion batteries are completely different so that there is no supply-side substitutability. As the Parties themselves point out, each of these batteries chemistries gives the respective rechargeable battery distinctive physical and performance characteristics. These characteristics also necessitate a different product design for the end-application so that during the life time of a certain model, the two types of batteries are not substitutable. However, even in the case of new models, most market participants have indicated that they would not switch chemistry in response to a permanent price increase of 5-10%.

⁴ Case No. COMP/M.5421-PANASONIC/ SANYO, Regulation (EC) No. 139/2004 Merger Procedure, 2009 EUR-Lex CELEX LEXIS 5421 (September 29, 2009), *available at* http://ec.europa.eu/competition/mergers/cases/decisions/m5421_20090929_20212_en.pdf.

1 And the EC report concluded that after obtaining pricing data from the parties to further investigate
2 battery types, “the pricing analysis points towards a separate market for NiMH batteries and a
3 separate market for Li-ion batteries.”

4 **B. Lithium Ion Batteries**

5 **1. Properties and types of LIBs.**

6 28. A Lithium Ion Battery generally contains three primary components: (1) the negative
7 electrode (cathode); (2) positive electrode (anode); and (3) the electrolyte. The negative electrode of
8 a conventional Lithium Ion Battery is made from carbon, typically graphite. The positive electrode is
9 a metal oxide (usually a layered oxide (such as lithium cobalt oxide), a polyanion (such as lithium
10 iron phosphate), or a spinel (such as lithium manganese oxide)). The electrolyte is typically a
11 mixture of organic carbonates such as ethylene carbonate or diethyl carbonate containing complexes
12 of lithium ions (usually lithium salts such as lithium hexafluorophosphate, lithium
13 hexafluoroarsenate monohydrate, lithium percolate, lithium tetrafluoroborate, and lithium triflate).

14 29. Internally, the battery has a separator between the cathode and anode and is filled with
15 the organic electrolyte solution. The separator prevents short-circuits that would occur if there were
16 contact between the anode and cathode. At the same time, the separator protects the electrolyte
17 solution and preserves the battery’s conductivity. In the recharging process, lithium ions are released
18 from the cathode into the electrolyte solution where they accumulate between the anode layers.
19 During the discharge process, the ions return to the cathode. The movement of lithium ions between
20 the cathode and the anode during the discharge process creates the electric current from the battery
21 which powers the specific device it is used in. The following diagram illustrates the different parts of
22 a Lithium Ion Battery as well as the discharge/recharge process.

Figure 2: Lithium Ion Batteries

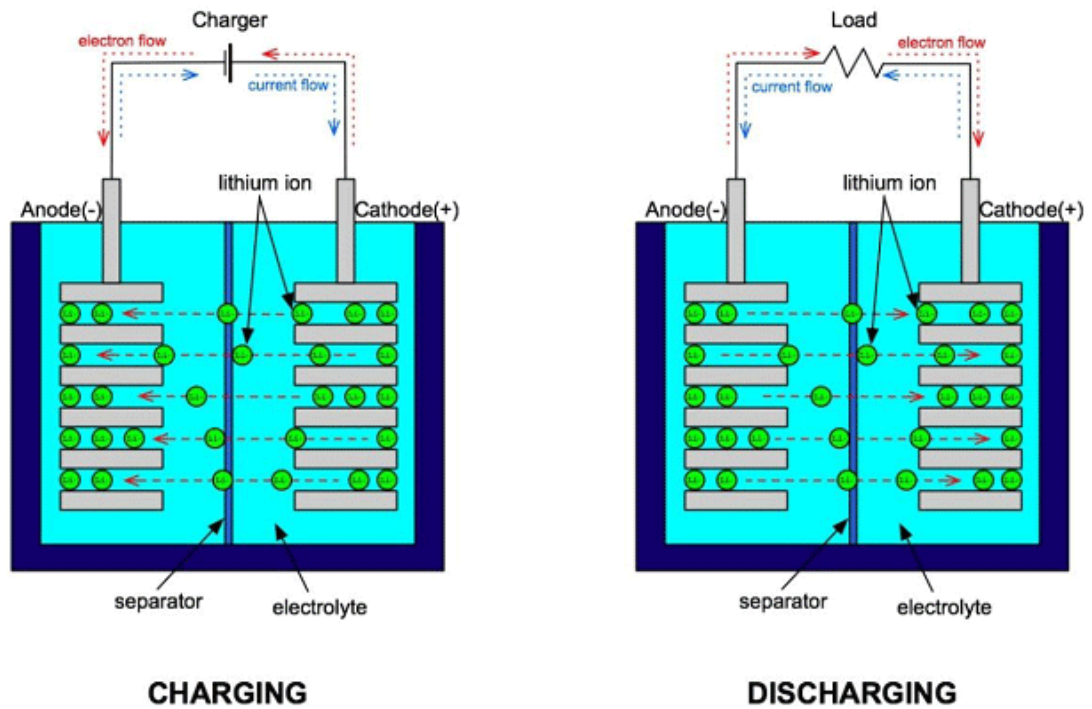

30. There are generally two primary steps in the manufacture of the batteries described herein. In the first step, the “cell” of the battery is manufactured which includes the cathode, anode, and electrolyte. The cell, and in some cases, multiple cells, are then assembled inside an enclosure. In some cases, certain protection circuitry is also added inside the enclosure. The assembled product is referred to as the “battery” or “module” and is the product that is placed inside a device to supply power to the device. All of the Defendants named herein manufacture both raw lithium ion battery cells as well as modules. The following is a depiction of multiple lithium ion battery cells placed inside an enclosure with added protection circuitry.

Figure 3: Lithium Ion Battery Cells Inside Enclosure

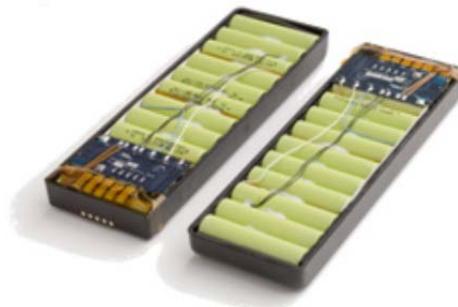

1 31. In addition to the manufacture and sale of raw lithium ion battery cells and modules,
2 the Defendants also sell raw cells to other entities commonly referred to in the industry as
3 “assemblers” or “packers.” In these cases, the raw lithium ion battery cells made by Defendants are
4 incorporated into a module by assemblers who assemble the cells (and if necessary, circuitry) and
5 then sell the module under their own brand name. Whether a module is manufactured by a Defendant
6 or a packer, the raw cells in a finished battery or module make up the overwhelming cost of a
7 finished lithium ion battery module.

8 32. Lithium Ion Batteries are generally divided into four different types: (1) small
9 cylindrical (solid body without terminals); (2) large cylindrical (solid body with large threaded
10 terminals); (3) prismatic, sometimes known as “square” (semi-hard plastic case with large threaded
11 terminals); and (4) lithium ion polymer, sometimes known as “pouch” (soft, flat body such as those
12 used in cell phones). Each Defendant manufactures and markets at least one type of Lithium Ion
13 Battery. Lithium ion cylindrical or prismatic batteries are used primarily in notebook computers,
14 camcorders, mobile phones, and other electronic devices. The following is a picture from Hitachi’s
15 website of cylindrical and prismatic lithium ion batteries:

16 **Figure 4: Cylindrical and Prismatic Lithium Ion Batteries**



22 33. Lithium ion polymer batteries have more freedom in battery shape which enables the
23 battery to be easily and perfectly tailored to fit the device. The exterior of the lithium ion polymer
24 battery is generally made of a laminate film which allows it to be more flexible in terms of its shape.

25 34. One of the primary distinguishing features of lithium ion polymer batteries is that the
26 lithium salt electrolyte is not held in an organic solvent, but rather in a solid polymer composite such
27 as polyethylene oxide or polyacrylonitrile. The dry polymer design offers advantages over the
28

1 traditional lithium ion battery in terms of fabrication and ruggedness since the electrolyte is a solid
2 polymer as opposed to a gel or liquid electrolyte.

3 35. Lithium Ion Batteries, as defined herein, include cylindrical, prismatic, and polymer
4 Lithium Ion Batteries.

5 36. Lithium Ion Batteries possess certain unique performance qualities which make them
6 the most popular form of rechargeable battery. In addition, because of these characteristics, Lithium
7 Ion Batteries are not interchangeable (not economic substitutes) with other types of secondary or
8 rechargeable batteries such as nickel-cadmium or nickel-metal hydride.

9 37. Unlike other forms of rechargeable batteries (such as nickel-cadmium or nickel-metal
10 hydride), Lithium Ion Batteries are the only rechargeable battery which do not suffer from any
11 “memory effect.” For example, if a nickel-cadmium battery is charged repeatedly to 70 percent
12 capacity, the discharge voltage will begin to fall sharply from the 70 percent even after a full charge
13 and eventually, the battery will be incapable of holding a charge. The battery essentially remembers
14 70 percent as the full capacity. Lithium Ion Batteries, on the other hand, do not suffer from the
15 memory effect, and there is no risk to reducing the capacity of the battery when only partially
16 charging the battery.

17 38. A second feature which makes Lithium Ion Batteries unique is that they are more
18 powerful than all other types of rechargeable batteries. For example, the nominal voltage of a nickel-
19 metal hydride rechargeable battery is 1.2 volts. The nominal voltage of a Lithium Ion Battery, on the
20 other hand, is 3.7 volts, nearly three times more powerful.

21 39. Lithium Ion Batteries also possess a higher “energy density” than other types of
22 rechargeable batteries. “Capacity” refers to the volume of electricity that a battery can hold. The
23 energy volume in a battery is the voltage times the capacity. Lithium Ion Batteries possess high
24 energy density, both per weight and per volume, as compared to other types of rechargeable
25 batteries. Essentially, a lighter and smaller Lithium Ion Battery can generate the same amount of
26 electricity as a heavier and larger battery of a different type. For example, Lithium Ion Batteries can
27 be as much as 70 percent lighter and 60 percent smaller in volume than nickel hydride batteries but
28 deliver the same amount of power.

40. Lithium Ion Batteries also retain their charge better than other types of rechargeable batteries. For example, Lithium Ion Batteries lose only about five percent of their charge per month when idle. Other types of rechargeable batteries, like nickel-metal hydride batteries, lose nearly 20 percent of their charge per month when idle.

2. LIBs are commodity products.

41. Because of their superior performance characteristics, and their small size, Lithium Ion Batteries have become the standard battery used in consumer electronic products. It is estimated that about 40 to 50 percent of all Lithium Ion Batteries used today are used in small consumer electronic products such as cell phones and notebook computers. Much of the remaining market for Lithium Ion Batteries is for use in digital cameras, power tools, and other devices. Figure 5 shows the different products by volume in which Lithium Ion Batteries are used between 2002-2010.

Figure 5: Shipments of Lithium Ion Batteries by Application

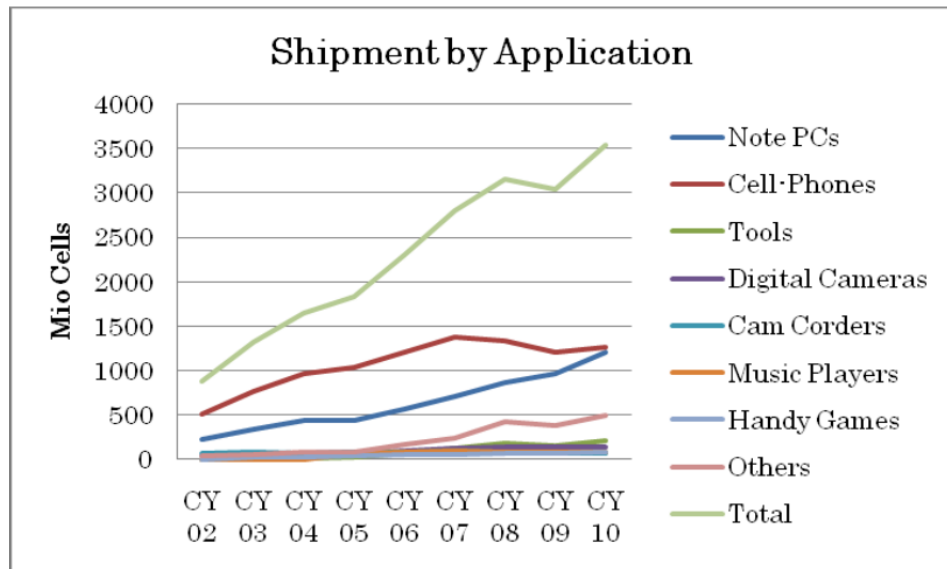

42. Lithium Ion Batteries are also highly standardized products, and interchangeable among the same type and across manufacturers. International standard-setting organizations, such as the International Electrotechnical Commission or the Institute of Electrical and Electronics Engineers develop standards to be followed by the manufacturers of Lithium Ion Batteries so that products which utilize Lithium Ion Batteries can be developed to accommodate a specific Lithium Ion Battery. For example, a Lithium Ion Battery “18650” refers to a cylindrical shaped battery measuring

1 18.6 millimeters in diameter by 65.2 millimeters in height with a nominal voltage of 3.6 volts and a
2 capacity of 2250mAh.

3 43. The Institute of Electrical and Electronics Engineers reported in 2008 that the “world
4 increasingly runs on lithium-ion batteries.” It continued that “[t]his is an industry ready for change
5 but not necessarily expecting it, let alone striving for it. The big companies that dominate lithium-ion
6 production – Sony, Panasonic, Sanyo, Samsung, and LG – are all selling batteries not much different
7 from the ones they sold five years ago. Only the initial capacity of batteries has been increasing, at
8 about 5 percent a year. Today they are *commodity products*, manufactured in huge quantities and
9 sold at vanishingly slim profit margins.”⁵

10 44. In May of 2003, *EE Times* reported:

11 Practical economics more than ever dictate product paths, and thus
12 there’s also a *consolidation of form factors* for both cylindrical and
13 prismatic (rectangular) shapes ... “The industry seems to be focusing
14 on *two standard polymer footprints*: 50 x 34 and 30 x 48 mm. Two
15 years ago, there were more than 20 different battery flavors.” ... To
16 keep their edge, [Japanese manufacturers] kept close tabs on the basic
17 consumer areas, by boosting the capacity of the *standard* 18650 Li-ion
18 cell, long viewed as a primary building block for notebooks.

19 * * *

20 “Lithium-ion batteries are still most widely used; the polymers are
21 picking up a bit, though,” he said, noting the leap in materials research
22 with various intermetallic compounds. “*Standardization* and cost are
23 the driving issues. *The number of package footprints is down to a
24 very few, because a lot of different products make design engineers
25 nervous.* All of this is driving costs lower.” Ultralife says it will boost
26 the capacity for the industry-standard 18650 Li-ion cell, viewed as a
27 *primary building block for notebooks*, to 2.4 A-h by the end of the
28 year.”⁶

45. In a detailed July 20, 2012 investor report titled “*Lithium-ion batteries – A Japanese
tech growth story?*” Citi Research, a division of Citigroup Global Markets, Inc. told its investor
clients that, with respect to notebook PC batteries, “a lack of progress in boosting battery output has

⁵ Tekla S. Perry, *The Lady and the Li-ion*, IEEE Spectrum (1 Mar 2008 5:00 GMT),
<http://spectrum.ieee.org/energy/renewables/the-lady-and-the-liion#>. (Emphasis added.)

⁶ Vincent Biancomano, *Lithium Batteries Eye PCs, Autos*, EE Times (May 8, 2003 2:51 PM
EDT), <http://eetimes.com/electronics-news/4124557/Lithium-Batteries-Eye-PCs-Autos>. (Emphasis
added.)

1 resulted in *increasing commoditization*,” and that “[t]he *commoditization* of cylindrical batteries
2 used in notebook PCs continues.”

3 46. Apple Inc., a major purchaser of Defendants’ Lithium Ion Batteries during the Class
4 period, presently states on its website: “Lithium-ion Batteries. Rechargeable lithium-based
5 technology currently provides the best performance for your Apple notebook computer, iPod, iPhone
6 or iPad. You can also find this *standard battery technology* in many other devices. Apple batteries
7 share the characteristics common to lithium-based technology in other devices.”⁷

8 47. Samsung presently states on its website that “Both prismatic and cylindrical type
9 batteries *have same [sic] operating mechanism basically*. Prismatic type is usually used for mobile
10 devices and its general capacity is 500~1200mAh; whereas cylindrical type is mostly used for
11 Notebook PC and camcorders and has 1600~2400mAh capacity which is higher than prismatic
12 type.”⁸

13 **III. DEFENDANTS CONSPIRED TO RAISE AND STABILIZE LITHIUM ION**
14 **BATTERY PRICES**

15 **A. Summary and Examples of Defendants’ Overt Acts in Furtherance of Their Conspiracy**

16 48. Defendants’ high-level executives engaged in a series of collusive meetings and
17 communications starting in or around 2000, and continuing into 2011, all in conscious furtherance of
18 their goal of inflating Lithium Ion Battery prices. Defendants varied the frequency of their collusive
19 meetings and communications according to market conditions, sometimes meeting twice a year,
20 sometimes quarterly, and sometimes within weeks or days of the last meeting or discussion.

21 49. Many of the Foreign Defendants have produced documents in this case which show
22 Defendants’ acts in furtherance of their conspiracy. These documents reflect at least dozens of
23 collusive meetings among Defendants. During these meetings, high-level executives with pricing
24 authority discussed confidential future plans and strategies concerning pricing, capacity, utilization,
25

26 ⁷ *Lithium-ion Batteries*, Apple, <http://www.apple.com/batteries/> (last visited June 13, 2013).

27 ⁸ *FAQ: Rechargeable Battery*, Samsung SDI,
28 http://samsungsdi.com/f_faqlist.sdi?post=E&category=SA (last visited June 13, 2013) (emphasis added).

1 demand, marketing and product development in furtherance and reinforcement of Defendants’
2 conspiracy.

3 50. In secret, Defendants shared past, present, and future production and capacity figures
4 and forecasts to facilitate the object of their conspiracy, that is, raising Lithium Ion Battery prices to
5 supra-competitive levels. Defendants’ collusive discussions concerning price, output, and capacity
6 provided necessary information to cartel members to reach agreement on what price levels should be
7 offered to customers, and whether to indeed increase or decrease supply in order to restrict price
8 competition. Defendants’ collusive discussions were also used to police, enforce, and verify that each
9 member of the cartel was adhering to Defendants’ plan to artificially raise Lithium Ion Battery
10 prices.

11 51. When memorializing their conspiratorial discussions, Defendants marked these
12 internal documents as “Confidential.” Samsung and LG prior to production in this case again marked
13 these discussions “Confidential,” emphasizing the secret, non-public nature of the collusive
14 communications between top-level executives of competing companies.

15 52. In these conspiratorial meetings, Defendants agreed to provide – and indeed did
16 provide – *company-specific*, highly detailed data and information, not merely aggregated or
17 industry-wide data. The information was *non-public* and was not shared with non-participating
18 companies or anyone else.

19 **1. Defendants’ collusive activities began at least as early as 2000 and continued**
20 **throughout the Class Period.**

21 53. By 2000, the Japanese Defendants produced 95 percent of the world’s secondary
22 batteries. In 1999 to 2000, however, the South Korean companies Samsung and LG entered the
23 business. Samsung and LG began mass production in 2000. Prior to that time, Samsung and LG
24 began their secret collusion with the Japanese Defendants. These collusive meetings involved
25 commercially-sensitive market information and not yet publicly available information, including
26 pricing information and future output and capacity details.⁹

27 ⁹ Defendants have produced documents memorializing many conspiratorial meetings, many of
28 which are in foreign languages. Plaintiffs have prepared initial translations of these documents for
reference herein.

54. For example, on August 16, 1999, the following executives from SDI and GS Soft Energy met at a presently unknown location:

Implicated Company	Employee Attending Collusive Meeting	Executive's Title
GS Soft Energy	"Honma"	Sales Dept. Head
	"Iue, Toshimasa"	President

Honma and Iue visited SDI and discussed the battery business and potential collaboration between competitors. A document memorializing this meeting was marked by the meeting participants as "strictly confidential."

55. On October 17, 2000, the following executives from competitors Samsung and Hitachi Maxell met at "Hitachi Maxell Shibuya Headquarters" in Japan from 10:00 a.m.-12:30 p.m.:

Implicated Company	Employee Attending Collusive Meeting	Executive's Title
Samsung from "Business Planning"	Ui Jin Yoo	General Manager
	Young No Kwon	Manager
	Seung Hee Yoon	Chief
Samsung from "M/E Business"	Yoo Mi Kim	Senior Manager
	Sung Sik Moon	Manager
Samsung from "Energy Lab"	Sang Won Lee	Manager
Samsung from "Tokyo Office"	Hee Seung Yoo	Senior Manager
	Young Taek Cho	Manager
Hitachi Maxell	"Genichi Fukabori"	General Manager, Secondary Battery Sales
	"Hiro Horike"	"Chief engineer, design"
	"Kenji Hanada"	"Chief secondary batteries sales"
	"Naoki Akagawa"	"Unknown, secondary batteries sales"

Agenda items discussed included "Business status," "Sales status," "Secondary batteries product status," "Production status," "Business strategy," and "Market outlook." The parties discussed Hitachi Maxell's "production status" of "2 million cells/m produced (less than 50% operation rate) but that "[d]espite the low operation rate, plan to expand capacities for major products."

56. On October 18, 2000, the following executives from competitors Samsung and Yuasa met at "Yuasa Odawara factory" in Japan from 9:30 a.m.-12:30 p.m.:

Implicated Company	Employee Attending Collusive Meeting	Executive's Title
Samsung from "Business Planning"	Ui Jin Yoo	General Manager
	Young No Kwon	Manager
	Seung Hee Yoon	Chief
Samsung from "M/E Business"	Yoo Mi Kim	Senior Manager
	Sung Sik Moon	Manager
Samsung from "Energy Lab"	Sang Won Lee	Manager
Samsung from "Tokyo Office"	Hee Seung Yoo	Senior Manager
	Young Taek Cho	Manager
Yuasa	Kenichi Takeuchi	Director, Research Development Division
	Taizo Harada	Deputy General Manager, Research Center
	Naoyoshi Nagata	Director, Planning and Development
	Kazuo Arai	General Manager, Research Development Center

Agenda topics included: "Business Status," Major research status," and "Development status." The parties discussed Yuasa's "Polymer battery capacity," described as "35K cumulative as of October. Can produce up to 300K cells if the facility is fully operated for 20 days a month."

57. The parties further discussed "Both companies' cooperation" and in regards to the "Purpose of cooperation," the parties communicated that "The two companies have been exchanging for 5 years since 1995 in the nickel hydride battery field." The parties continued that "SDI is in the electronics field and Yuasa is in the commercial field, so there would be a lot *for the two companies to be complementary.*" (Emphasis in original.) The parties continued "*With the idea that the two companies can Win-Win as long as we maintain the cooperation, not the competition, [I] thought of maintaining the cooperation between the two companies.*" The parties continued regarding the "Cooperation method" that "Rather than trying to achieve something big from the beginning, it would be good, after entering into an NDA, to set various themes and proceed with something feasible through exchanges." The parties continued that "[t]here is ample room for development of ion batteries and polymer batteries, so it is possible to *avoid duplicate investment through the cooperation of the two companies.*" (Emphasis in original.)

1 58. Also on October 18, 2000, the following executives from Samsung and Matsushita
2 met at “Matsushita, Chigasaki factory” from 3:00 p.m.-5:00 p.m.:

Implicated Company	Employee Attending Collusive Meeting	Executive’s Title
Samsung from “Business Planning”	Ui Jin Yoo	General Manager
	Young No Kwon	Manager
	Seung Hee Yoon	Chief
Samsung from “M/E Business”	Yoo Mi Kim	Senior Manager
	Sung Sik Moon	Manager
Samsung from “Energy Lab”	Sang Won Lee	Manager
Samsung from “Tokyo Office”	Hee Seung Yoo	Senior Manager
	Young Taek Cho	Manager
Matsushita	Yukio Aoyagi	General Manager, Planning and Marketing
	Tsuyoshi Mori	Manager, Planning and Marketing
	Mami Masuda	Chief, Planning and Marketing

3
4
5
6
7
8
9
10
11
12
13
14
15
16
17
18
19
20
21
22
23
24
25
26
27
28

Agenda items included “Business status,” “Market outlook,” and “Production capacity.” The parties communicated that Matsushita’s production capacity for “Lithium ion battery” was “10 million cells/m (cylindrical 6 million / prismatic 4 million)” with a “plan to expand to 12 million cells/m” and that for “Polymer” it was “1 million cells /m, (few are actually produced).”

59. On October 20, 2000, the following executives from competitors Samsung and Sony met at “Gate City Osaki Headquarters” in Tokyo, Japan at 10:00 a.m.:

Implicated Company	Employee Attending Collusive Meeting	Executive’s Title
Samsung from “Business Planning”	Ui Jin Yoo	General Manager
	Young No Kwon	Manager
	Seung Hee Yoon	Chief
Samsung from “M/E Business”	Yoo Mi Kim	Senior Manager
	Sung Sik Moon	Manager
Samsung from “Energy Lab”	Sang Won Lee	Manager
Samsung from “Tokyo	Hee Seung Yoo	Senior Manager

Implicated Company	Employee Attending Collusive Meeting	Executive's Title
	Young Taek Cho	Manager
Sony	Chiho Konno	General Manager, "Energy Company, Products Planning"
Sony	Seiichi Oiyama	Manager, "Energy Company, Battery Business Div., LIB Dept."

Agenda items discussed included "Business status and strategy," "Production capacity," "Product status," "Market outlook," "Market size," "Target market," and "Li-ion vs. polymer competition."

The parties discussed the relationship among cylindrical, prismatic, and polymer batteries, and agreed that "*Battery makers should rather create a new market than aggravating the competition amongst the makers.*"

60. Also on October 20, 2000, the following executives from competitors Samsung and GS-Melcotec Co. ("GSMT") met at "Kanda headquarters" in Tokyo, Japan at 2:00 p.m.:

Implicated Company	Employee Attending Collusive Meeting	Executive's Title
Samsung from "Business Planning"	Ui Jin Yoo	General Manager
	Young No Kwon	Manager
	Seung Hee Yoon	Chief
Samsung from "M/E Business"	Yoo Mi Kim	Senior Manager
	Sung Sik Moon	Manager
Samsung from "Energy Lab"	Sang Won Lee	Manager
Samsung from "Tokyo Office"	Hee Seung Yoo	Senior Manager
	Young Taek Cho	Manager
GS-Melcotec	Eiji Yamada	General Manager, Marketing and Sales
GS-Melcotec	Kazunori Nagahata	Manager, Marketing and Sales
GS-Melcotec	Keini Matsuo	Unknown title, Overseas Marketing and Sales

Agenda items discussed included "Business status and strategy," "Mid-term business plans," "Market outlook," and "Li-ion vs. polymer competition." GS-Melcotec communicated its detailed production figures, specifically "Producing 5.5 million cells/month (entire production in Kyoto) – Prismatic 4.8 million/month (9 lines) . . . Polymer 300K / month (1 line)." GS-Melcotec

1 communicated its “Mid-term business plans”: “10 million cells/m in 2001” and “total 20 million in
2 2004/2005 (need to maintain the market share).” The parties further discussed GS-Melcotec’s
3 “Strategy to focus on Prismatic (to respond to cellular phone” demand.

4 61. Also, on October 20, 2000, the following executives from competitors Samsung and
5 NEC met at Chuncheon DakGalbi restaurant in Shinjuku, Tokyo, Japan at 6:00 p.m.:

Implicated Company	Employee Attending Collusive Meeting	Executive’s Title
Samsung from “Business Planning”	Ui Jin Yoo	General Manager
	Young No Kwon	Manager
	Seung Hee Yoon	Chief
Samsung from “M/E Business”	Yoo Mi Kim	Senior Manager
	Sung Sik Moon	Manager
Samsung from “Energy Lab”	Sang Won Lee	Manager
Samsung from “Tokyo Office”	Hee Seung Yoo	Senior Manager
	Young Taek Cho	Manager
NEC	Ryuichi Matsumoto	“overseas sales”

14 Agenda items included “Business Status and Strategy,” “Pouch-Li-ion production status,” “Li-ion
15 battery production status,” the “Market outlook,” the “Cylindrical market,” and a “Li-ion vs.
16 Polymer comparison outlook.” The parties discussed NEC’s “pouch battery volume” and its “full
17 capa: 100K cells/m, actual production: 50K cells/m,” and its “Li-ion battery production status” –
18 “Capa – 5 million cells/m; 3 million cells / m being produced” and its “Plan to increase production to
19 8 million cells/m by June 2001.” The parties further discussed that NEC’s sales were “95% overseas
20 and 5% domestic” and that “[o]f the 95% . . . 30% is USA.” The parties further communicated about
21 the “**Overall oversupply.**”

22 62. On October 23, 2000, Samsung’s Senior Manager Hee Seung Yoo conducted a
23 “Phone interview” with Sanyo overseas sales Senior Manager “Tachihara,” and discussed Sanyo’s
24 “Production status,” *i.e.*, “15 million shipped since August 2000” and that “[o]f those, 10 million or
25 more are prismatic Li-ion” and that Sanyo’s “Overall strategy” was to “focus on slim prismatic
26 batteries.”

63. Defendants' collusive meetings continued in 2001, reflecting the same pattern often seen in subsequent years – a high frequency of intensive meetings often occurring in back-to-back days, with Samsung visiting numerous Japanese companies in Japan to facilitate collusion. Internal company memoranda suggest that the following occurred:

Date of Meeting	Meeting Location	Meeting Participants	Topics Communicated About
5/1/2001	Unknown	LG Chem and Sony Meeting. LG Chem: Vice President Gyu Pyo Hong; Sr. Manager S.H. Kwak. Sony: Director Nishi.	Introduced new representatives for each company. Discussion of “cooperation” between the two companies.
5/7/2001 (9:30 – 11:30 am)	Tokyo, Japan	SDI meeting with GS Yuasa. SDI: Unknown GS Yuasa: Aoki, Director	Agenda: NDA signing, cross-licensing, regular bilateral meetings (Plans a working-level technology meeting in the second half. Meetings will be held biannually.)
5/7/2001 (2-4 pm)	Tokyo, Japan	SDI meeting with Sony Energy Inc. Sony: Kazi or Gazi (President) SDI – Unknown	Agenda: Production in Mushaku, China (purpose, target market, domestic sales?); why focus on polymer business?; polymer market size? Future polymer battery market size? Reason for a selling price reduction? What are Sony's countermeasures?
5/7/2001	Tokyo, Japan	SDI meeting with GS Yuasa. Yuasa: Aoki (Director) SDI – Unknown	Dinner meeting.
5/8/2001 (10-11:30 am)	Tokyo, Japan	SDI meeting with Toshiba. Toshiba: Sumimoto (VP) SDI: Unknown	Meeting.

Date of Meeting	Meeting Location	Meeting Participants	Topics Communicated About
5/8/2001 (1-3 pm)	Tokyo, Japan	SDI meeting with GS Melcotec. GS Melcotec: Okada (GM) SDI – Unknown	Meeting Agenda: Short/long term market outlook? What's GSMT's final M/S achievement goal? Which product will you focus – prismatic, ion pouch, polymer? Opinion on GSMT's NCB (pouch type) and plan for expansion? Mitsubishi's role in GSMT? GSMT's plan for overseas business?
5/9/2001 (3-5 pm)	Osaka, Japan	GS Soft Energy meeting with SDI Sanyo: Honma (Sales Dept Head) SDI – Unknown	Meeting Agenda: Expansion of lithium ion battery production, overseas business (including production in China), opinion on reason of/response to rapid price reduction
5/10/2001 (10:00am – 12 pm)	Osaka, Japan	SDI meeting with Matsushita Battery Industrial (MBI) Matsushita: Kawase (Director) SDI – Unknown	meeting Agenda: Matsushita's major sales strategy? Profitability? What is the optimal royalty level for Bellcore PLI batteries? Polymer battery outlook? Will you continue Stacking type PLI battery business?
8/26/2001	Unknown	LG Chem and Sony Meeting LG Chem: VP Jong Pal Kim; General Manager Woon Hyun Hwang; Senior Manager S.H. Kwak Sony: Mr. Gazi; CEO of Sony Energy Co. Mr. Nishi.	New company representatives were introduced and Sony "asked for cooperation."

Date of Meeting	Meeting Location	Meeting Participants	Topics Communicated About
9/17/2001 (noon – 1 pm)	Tokyo, Japan	SDI meeting with Sony Media World (guided by FPD Division’s Aoki) Sony: Aoki (Department Head) SDI: President, EVP Hong, EVP Jung, VP Ahn, Senior Manager Yoo	Meeting “Sony Media World” Tour Meeting participants designated meeting materials as “strictly confidential.”
9/18/2001 (noon to 3:30 pm)	Osaka, Japan	SDI meeting with Matsushita Battery Industrial (MBI). Matsushita: Kawase, Hirushi (Director) Saito (Department Head) SDI – President, EVP Hong, EVP Jung, VP Ahn, Senior Manager Yoo	Meeting Battery Exhibit Hall Tour Matsushita Digital Exploratorium “Ehii” Tour Meetings participants designated meeting materials “strictly confidential.”
9/19/2001 (11 am – 1 pm)	Osaka, Japan	SDI meeting with GS Soft Energy Sanyo: Kan, Akira (Vice President) SDI: President, EVP Hong, EVP Jung, VP Ahn, Senior Manager Yoo	Meeting / lunch Meeting participants designated meeting materials as “strictly confidential.”

64. On November 5, 2001, the following executives from competitors Samsung and GS-Melcotec met at Shibaura Futou, GS-Melcotec at 3:00 p.m. to 5:30 p.m.:

Implicated Company	Employee Attending Collusive Meeting	Executive's Title
SDI	Chan Sik Park	General Manager
	Young No Kwon	Senior Manager
	Young Tae Cho	Manager
	Han Myung Kim	Manager
	Seung Won Lee	Manager
GSMT	Tanaka	Vice-President
	Okada	Sales Director
	Sato	Sales Dept. Head
	Nagahata	Sales Dept. Head

Agenda items included "Market outlook," "Polymer market," and "Cylindrical line." The parties discussed GSMT's production "line status" of "14 lines, total 7.5 million cells/m CAPA (excluding cylindrical), "Prismatic – 10 lines (CAPA is based on three teams in two shifts for 24 hours)," "Kyoto – 9 lines (Lines 1 to 3 CAPA 40,000 cells/month, Lines 4 to 9 500-600,000 cells/month , Shanghai China (Mushaku)– 1 line (1 million cells/m), and "Polymer – 4 lines (CAPA 1.8 million/m)" as well as Locations – "Pack – Kyoto (Unj, 2 million/m), Shanghai (Pusong, 2/million/m)" and "Sales-GSMT (Tokyo), GMUS (California), GMEU (UK), GMTW (Taiwan)." The parties further discussed a "Market Outlook," and GSMT's specific projections for its projections of "Prismatic" and "Polymer" production for 2002, 2003, 2004, and 2005." The parties further discussed a "proposal" to "[s]eek collaboration for pouch battery type" and that "[d]evelopment of polymer battery market and market information exchange requested." Finally, the parties discussed "Cylindrical line – Line stopped in the first half of 1999 due to drastic cylindrical price decrease."

65. On November 6, 2001, the following executives from Samsung and Toshiba met at the "Shibaura Toshiba Display Parts and Material Company Meeting Room" at 9:30 a.m.-11:00 a.m.:

Implicated Company	Employee Attending Collusive Meeting	Executive's Title
SDI	Young No Kwon	Senior Manager
	Young Tae Cho	Manager
	Han Myung Kim	Manager
	Seung Won Lee	Manager
Toshiba	Iwasaki	Group Leader
	Ozaki	Planning Production Dept. Head
	Tatsukawa	Planning Leader

1 Agenda items included “Company and line status.” The parties discussed Toshiba’s “Line status” for
 2 “Cylindrical: 2 lines, 1.5 million / m CAPA,” “Prismatic: 16 lines, 3 million / m CAPA,” “Polymer:
 3 2 lines, 1.5 million /m CAPA.”

4 66. Also on November 6, 2001, the following executives from Samsung and Sony met at
 5 the “ Ohsaki SONY Gate City West Tower” at 2:00 p.m.-3:30 p.m.:

Implicated Company	Employee Attending Collusive Meeting	Executive’s Title
SDI	Young No Kwon	Senior Manager
	Hee Seung Yoo	Senior Manager
	Young Tae Cho	Manager
	Han Myung Kim	Manager
	Seung Won Lee	Manager
Sony	Furuya	Planning Management General Manager
	Konno	Marketing Planning General Manager
	Nagamine	Strategy Department Head
	Sekai	Marketing Planning Division Technology Dept. Head noted as Ph.D. in Engineering

14 Agenda items included “Line and market status,” “Line and Capa status,” and “Polymer outlook.”
 15 The parties discussed Sony’s “Line and Capa status” of “15 million/m CAPA,” “Prismatic – 4 lines 2
 16 million/m CAPA,” “Polymer – 3 million/m (Japan and China),” “Cylindrical – 10 million/m”)” and
 17 that Sony “[W]ould like to expand lines for cylindrical.”

18 67. On November 7, 2001, the following executives from Samsung and Matsushita met at
 19 the Kanagawa Matsushita Factory at 1:00 p.m. to 3:00 p.m.:

Implicated Company	Employee Attending Collusive Meeting	Executive’s Title
SDI	Young No Kwon	Senior Manager
	Hee Seung Yoo	Senior Manager
	Young Tae Cho	Manager
	Han Myung Kim	Manager
	Seung Won Lee	Manager
Matsushita	Mori	Group Leader
	Shimizu	Group Leader

25 Agenda items included “Market outlook,” and “Capacity status.” The parties discussed Matsushita’s
 26 capacity, *i.e.*, “Cylindrical – 5-6 million/m (3.5 line relative to SDI line capa)” and “Prismatic – 4
 27 million/m (plan to expand to 6 million in 2002).”

68. Between March 12, 2002, and March 16, 2002, Samsung met in Japan with Sanyo, Sony, Panasonic, Maxell and GSMT. Specifically, on March 14, 2002, from 10:00 a.m. to 12:00 p.m., the following executives from Samsung and Sony met in the fifth floor conference room of Sony's Gate City West Tower in Osaka:

Implicated Company	Employee Attending Collusive Meeting	Executive's Title
Sony	Geumya (Konno)	General Manager covering Marketing Strategy Division
	Hiratsuka	General Manager for Technology Strategy
Samsung	Jeon, In Sang	General Manager
	Cho, Young Taek	Senior Manager
	Kim, Han Myoung	Manager

Agenda items discussed by these executives included "Cylindrical Type Capa.," meaning capacity, "Concerning the Note PC Market," "Square Type Market Forecast," meaning prismatic batteries, and "Polymer." The Samsung and Sony executives communicated their companies' production capacities, and then a "Supply and Demand Forecast," agreeing that "the supply and demand shall be considered as tight." The executives then agreed that they would "*refrain from Capa. [capacity] extension*," and that "[u]nder the current market condition where profit realization is very hard" that "[f]ull operation of the lines currently possessed is the best choice."

69. On March 14, 2002, Samsung met in Japan with Hitachi Maxell. Specifically, between 2:00 p.m. to 4:00 p.m., the following executives from Samsung and Maxell met at the Shibuya Hitachi Maxell 7th Floor Conference Room:

Implicated Company	Employee Attending Collusive Meeting	Executive's Title
Samsung	Jeon, In Sang	General Manager
	Cho, Young Taek	Senior Manager
	Kim, Han Myoung	Manager
Hitachi Maxell	Unknown	Unknown

Agenda items included "[t]he Demand for Square Type," the "[f]orecast of Supply and Demand for Square Type," the "Polymer Market," and "Concerning Sales of Cylindrical Type Line."

70. On March 15, 2002, the following executives from Samsung met in Japan with Sanyo executives from 9:30 a.m. to 12:00 p.m. in the Samsung Japan Conference Room:

Implicated Company	Employee Attending Collusive Meeting	Executive's Title
Samsung	Jeon, In Sang	General Manager
	Kim, Han Myoung	Manager
	Cho, Young Taek	Manager
Sanyo	Sam (Mori)	Strategy Group Leader and General Manager

Agenda items included “Supply and Demand for Cylindrical Type,” “Cylindrical Market for Note PC,” and “Forecast on Supply and Demand of Square Type.” Sanyo communicated that its “cylindrical type equipment Capa. is approximately 10 million/month – High-speed line: 200~250 ten thousand/month X 3 lines – Low-speed line: 300 ten thousand/month.” Regarding the “Cylindrical Market for Note PC,” the companies communicated that while prices had dropped more significantly in prior years, “in 2002, it is expected that it will be 3%/half year.” The conspirators further communicated that as compared to Panasonic, Maxell, NEC and GSMT, “Sanyo’s operating rate is highest, *but they plan to avoid the extension in the future* and remodel the lines to respond to new Cell.”

71. Between October 22, 2002, and October 25, 2002, Samsung conducted another round of collusive meetings with its competitors in Japan. For example, on October 22, 2002, the following executives from Toshiba and Samsung met at Toshiba Display, Component Materials Corporation Battery Energy Department:

Implicated Company	Employee Attending Collusive Meeting	Executive's Title
Toshiba	Hiravama Kazunari	General Manager of Business
	Ozaki Hidemichi	General Manager of Planning Production
Samsung	Ahn, Ki Hoon	Business Team Leader
	Oh, Yo Han	General Manager
	Kim, Han Myoung	Manager
	Cho, Young Taek	Senior Manager

Agenda items included “Cylindrical Type,” and “Square Type.” The companies communicated that for cylindrical, “The price of 2.2Ah to Motorola-ESG is almost the marginal cost level,” and communicated regarding the “2003 price for mobile phone use” and that “it is expected that the demand for discount will be approximately under 10%.” The conspirators further “*[a]greed to hold the regular interchange staffer-centric* conference (around end of November) → once every six months.”

72. Also on October 22, 2002, the following executives from GSMT and Samsung met at GS-Melcotec Business Department (Tokyo):

Implicated Company	Employee Attending Collusive Meeting	Executive's Title
GSMT	Lin Quian Zuolang	President
	Kobayashi Koichi	Vice President
	Toshihide Tanaka	Director (Development)
	Shinzo Maeda	Director of Sales, Board Member
Samsung	Ahn, Ki Hoon	Business Team Leader
	Oh, Yo Han	General Manager
	Kim, Han Myoung	Manager
	Cho, Young Taek	Senior Manager

The conspirators agreed regarding “CAPA extension → Rather than new extension, focus on productivity with the remodeling the existing line,” and that “Current supply and demand BALANCE is good because after 2001 investment for extension there has been no additional extension.” The conspirators further agreed that while “Most of the companies are contemplating additional extensions depending on 2003 demand forecast.” “We should be careful based on the experience that there was oversupply caused by 2001 overinvestment.” Samsung further noted the discussion of the “Cooperative Relation with Our Company.”

73. On October 24, 2002, the following executives from GS Soft Energy and Samsung met at GS Soft Energy:

Implicated Company	Employee Attending Collusive Meeting	Executive's Title
Samsung	Ahn, Ki Hoon	Business Team Leader
	Oh, Yo Han	General Manager
	Kim, Han Myoung	Manager
	Cho, Young Taek	Senior Manager
GS Soft Energy	Honma	Vice President
	Noguchi	General Manager of Management

The conspirators agreed that with respect to the “Forecast on Market from Now on” it was “*necessary to be careful in supply ability expansion.*” The conspirators cautioned each other regarding the “[e]xperience of oversupply due to the whole industry’s optimistic market prospect in 2001.” The executives further agreed that “*With price competition only, all will be in trouble → have to make the industry Healthy.*” They further discussed a “strategy to get rid of a company which disturbs the market.” Samsung noted in its meeting notes “Let’s talk separately with General

1 Manager of Business, Ahn later.” There also were pricing discussions between SDI and Sanyo with
2 respect to Sanyo’s 2.0A battery – a popular product.

3 74. On October 25, 2002, the following executives from Matsushita and Samsung met at
4 Matsushita Battery Industrial Co., Ltd.:

5 Implicated Company	Employee Attending Collusive Meeting	Executive’s Title
6 Samsung	Ahn, Ki Hoon	Business Team Leader
	Oh, Yo Han	General Manager
	Kim, Han Myoung	Manager
	Cho, Young Taek	Senior Manager
8 Matsushita	Futtsu Toshiyuki	Vice President of Secondary Battery
	Norio Saito	General Manager of Marketing
	Yasuo Anno	Marketing Correspondence Leader
	Shimizu Akihiro	Management Planning Division Commodities Strategy Team 1 Leader
	Takagi Hiroki	Management Planning Division Councilor

11 Agenda items included “Cylindrical Type” and “Square Type.” Matsushita discussed a recent
12 “supply shortage of cylindrical type (reduction of Matsushita’s M/S)” and communicated that the
13 “price discount cut may become small; *however, there is no plan to reduce the price ever.*”
14 Regarding the “Market Forecast from Now on,” Matsushita “do not expect considerable growth in
15 the 2003 market” and “[i]they hope not to reduce the price competitively.” Samsung later internally
16 described, “Although it was a joke, in the case that there is a merger like Sanyo/GS-MT, or there is a
17 request to recommend a company that wishes to cooperate [i]n reply, if Matsushita experiences
18 difficulties, they would like us to take care of them.”

19 75. Defendants’ collusive meetings continued apace in 2003. For example, on or about
20 June 26, 2003, executives from Samsung and GS Soft Energy met in Japan at Sanyo’s headquarters,
21 and communicated to each other their specific “2Q Sale Forecast” for each of them broken down by
22 “Cylindrical Type, “Square Type” and “Polymer.” They then communicated to each other their
23 projected “2003 (March 2004 period) Sale Forecast,” again broken down by each of the three battery
24 types. They further communicated to each other their “Capa status” (capacity status) again broken
25 down by each of the battery types, further broken down into potential and actual production by units
26 of ten thousand units /month. The conspirators further communicated regarding the “Sanyo Capa
27
28

1 Extension Plan,” detailing the “Cylindrical Type: 1,000 → 1,200 ten thousand unit,” the “Square
2 Type: 1,600 → 2,000 ten thousand units,” and “Polymer: nothing.”

3 76. On July 15, 2003, the following executives from Samsung and Toshiba met at 2:00
4 p.m. at a conference room within the Japan Tokyo ANA Hotel:

Implicated Company	Employee Attending Collusive Meeting	Executive’s Title
Samsung	Yoo, Eui Jin	Executive Director at Administration Planning Team
	Cho, Young Taek	Senior Manager at Japan Branch
Toshiba	Kazunori, Fukuma	Person in charge of Display – Parts Materials en banc
	Kubo Hiroshi	Display – Parts Materials en banc Administration Management Division Staff Officer

5
6
7
8
9
10
11 The conspirators discussed that Toshiba’s battery business was for sale, and that its executives were
12 also meeting with a company presumed to be LG regarding a possible sale. The conspirators
13 discussed the significant intellectual property assets that, apparently due to the operation of law,
14 would not be allowed to be transferred to a buyer. Samsung asked “Do you intend to keep IPR
15 [intellectual property rights] while not running the business?” Toshiba responded that “We are not
16 going to run the business and attached the manufacturing (AT Battery) → patent free. Cross License
17 (C/L) with Sanyo and Sony has been reached.” Toshiba further stated that it “is negotiating with
18 other companies, and we are making proposal to 2 Korean companies as well as Japanese
19 companies.” Samsung stated that “We have formed a connection for a long time through liaison
20 conferences with Toshiba so that it will be significantly reviewed as a matter of concern of Samsung
21 Group.” Toshiba communicated detailed capacity and operating rate information.

22 77. On October 2, 2003, the following executives of Samsung and GS Soft Energy met at
23 7:00 p.m. at Tokyo Shinjuku Restaurant:

Implicated Company	Employee Attending Collusive Meeting	Executive’s Title
SGS	Nagahata	General Manger in Charge of Marketing / Sales
Samsung	Kim, Han Myoung	ME Sales: Manager
	Cho, Young Taek	Japan Branch: Senior Manager

1 The conspirators communicated that “[t]here is a grand-scale extension of Sanyo, but it is getting
2 concentrated / emphasized on Nokia.” The conspirators communicated regarding their “Price
3 Forecast,” and communicated that “B/Cell 8% (Pack 10%) drop forecasted,” and that “B/Cell is
4 expected to drop approximately 8%, but it could grow due to the influence of China” and that “[i]n
5 Pack condition (including cell 8%), a 10% price drop is expected.” The conspirators communicated a
6 very detailed “Extension Trend by Each Company” with “Equipment Company Information” shared
7 and then “Verified” – for SGS, in regards to a 100 ten thousand extension, Sanyo “considered at the
8 beginning 2 line extensions, but now, nothing has been decided” and “it is very likely that they will
9 extend to a Japan (Tokyo) factory) and “[i]t is very likely, first, 1 line, 1 million; and it is expected to
10 produce next spring at earliest.” With respect to Sanyo, details were exchanged regarding
11 “Cylindrical type September 120 ppm (440 ten thousand) completion,” “Square type China 150 ten
12 thousand extension completed, additionally, it is scheduled 4 line extensions,” and that “[e]xtension
13 of cylindrical type 300 ten thousand was completed in spring, and the after plan is unknown” and
14 “Square type is proceeding as planned.”

15 78. Defendants’ collusive meetings continued in 2004. On February 5, 2004 Seok Hwan
16 Kwak of LG (Senior Manager, Tokyo Office) sent an email to Naito Toshiaki at Sony about an
17 upcoming meeting between several executives at both companies. Kwak wrote, “It has been a quite
18 some time since we met last time. . . . ***Thank you ALWAYS for receiving my phone with a pleasant***
19 ***voice.***” Mr. Kwak of LG then referred to their phone conversation earlier that day, stating that the
20 Executive Vice President of Information & Electronic Materials Company and the Vice President of
21 Battery Business Division would like to “meet you and your people to show their salutation/share the
22 GENERAL information of Secondary Battery business and etc.” Kwak requests three days in early
23 March that would work for Toshiaki, and confirms that “[o]f course, we will visit at your site and . . .
24 we hope to meet your responsible people including Energy Company’s President and [Japanese
25 characters] since it is their first time with a new position to SONY. . . .” He lists LGC’s participants
26 at the meeting as: 1) Soon-Yong Hong, Executive Vice President (“You’ve met him before . . .”),
27 2) Myung-Hwan Kim, Vice President Battery Business Division, and 3) Seokh-Hwan Kwak, Leader,
28

1 Tokyo Information & Technology Center. He concludes by saying that “[a]gain, *SONY’s kind*
2 *cooperation is always appreciated by LGChem.*”

3 79. On February 23, 2004 an internal LG email was sent from Assistant Manager Yoo
4 Sung Oh to General Manager Hyun Sik Park (Battery Planning Development Team). The email
5 included information in preparation for a meeting with Sony. Oh wrote: “This is the content on the
6 people to meet, summarized by Senior Manager Kwak, Seok Hwan, regarding the March 2 Sony
7 meeting of the President and the Division Leader. Please refer to it.” Oh forwarded an email from
8 Senior Manager Seok Hwan Kwak of the Battery Planning and Development Team and Assistant
9 Manager Yoo Sung Oh. That email begins, “*Dear Executive Vice President, Regarding SONY, I*
10 *would like to remind you of the LGC’s meeting history.*” The email then describes a detailed history
11 of meetings between LG and Sony, and a comprehensive chart of Sony’s organization within its
12 “electronics-related” business. It ends by mentioning a meeting (and meal) with Sony’s Mr. Naito
13 and Mr. Kamiyama on February 26. The following is a brief summary of the meetings between LG
14 and Sony:

15 (a) **Sony Meeting History**

16 (i) **May 2001**: Vice President Gui Pyo Hong and Senior Manager Seok
17 Hwan Kwak “met Director Nishi, introduced and asked for cooperation.”

18 (ii) **August 26, 2001**: Executive Vice President Jong Pal Kim, General
19 Manager Woon Hyun Hwang, and Senior Manager Seok Hwan Kwak were “introduced to Mr. GAZI,
20 then CEO of the Energy Company, and Director Nishi, and asked for cooperation.”

21 (b) The next heading reads: “People EVP Hong had met since then”

22 (i) **July 23, 2002**: “EVP Hong Division leader Mr. HOSOZAWA/Mr.
23 NAITO in charge of Cellular first greeting and asked for cooperation (on the business trip where he
24 met MBI/SONY/SANYO/Toshiba/MCC division leaders).”

25 (ii) **November 21, 2002**: “Afterwards, received a proposal for the
26 acquisition of Sony Prismatic K5 line, and regarding K5, EVP Hong came to Japan again and met
27 people, such as Mr. Katayama (executive in charge of technology) of the Koriyama factory, other
28

1 than division leader Mr. HOSOZAWA. Afterwards, LGC completed the K5 acquisition on June,
2 2003.”

3 (c) The document goes on to outline the attendees of the upcoming February
4 meeting between Sony and LG: “Since then, it is the first SONY visit by EVP Hong, and the
5 attendees this time are: Mr. Nakagawa (appointed as the president of SONY Energy Company from
6 2002); Mr. Naito (in charge of Cellular Battery); Mr. Kamiyama (in charge of business management
7 planning and strategy); Mr. HOSOZAWA, who was the division leader of PCC division, that he met
8 before. . . .” Kwak concludes by asking for Assistant Manager Yoo Sung Oh to tell him any
9 additional questions “EVP” has before Kwak meets with Mr. Naito on February 26.

10 80. On February 26, 2004, LG and Sony executives met, *i.e.*, for Sony, Hirokazu
11 Kamiyama, the PCC Division Leader as of March 1, 2004, and Toshiaki Natio, the Cellular Battery
12 Department Leader, PCC Division, Energy Company, and for LG, Seok Hwan Kwak, the Senior
13 Manager, TITC. The meeting minutes prepared by Mr. Kwak and emailed internally stated “Please
14 discard after reading.” LG communicated:

15 **As Executive Vice President Hong mentioned during his previous**
16 **visit to SONY, SONY and LG can regard each other as**
17 **competitors in terms of secondary Li-Ion battery but we are**
18 **engaged in a friendly competition to promote the growth of the**
19 **overall Li-Ion industry, and he asked for mutual collaboration in**
20 **order to avoid any bloodshedding competition over just prices. So**
21 **we’d like to speak in a frank manner.**

22 81. An internal LG document, “President Minutes on Business Trip to Japan,” describes
23 meetings that took place March 2 and 3, 2004 in a meeting room at Sony’s Shinagawa Seaside North
24 Tower in Tokyo, the Akasaka Hotel, and various other locations in Japan. The participants from
25 Sony and LG included:

Implicated Company	Employee Attending Meeting	Collusive Executive’s Title
Sony	Mr. Nakagawa	President of Energy Company
	Mr. Kamiyama	Designated PCC Division Leader
	Mr. Naito	GM of Cellular Batteries
	Mr. Matsumoto	T-BTC attendees
LG	Mr. Tanina	T-BTC attendees
	Moon	Manager
	Mr. Hirano	Executive Vice President
	Soon Yong Hong	President of I & E Materials

Implicated Company	Employee Attending Collusive Meeting	Executive's Title
	VP Myung Hwan Kim	Battery Division Leader
	Seok Hwan Kwak	Senior Manager

(a) An initial summary of the meeting explains, “LG Chem has maintained friendly relations with SONY for the growth of the Li-Ion battery industry. The meeting was about introducing LG Chem’s new management/President of Energy Company at SONY, and the new Division leader to each other, sharing information and asking for cooperation among companies.” Detailed Sony organizational charts are included, focusing on business structure and, specifically, Sony’s Lithium Ion Battery operations. The two companies discussed all aspects of the business: demand, products, supply, technological development, and prices. The document also discusses other companies’ information: “SANYO also announced price hikes to customers and MBI also plans to do so. Afterwards, [it] received the opinions of NEC/Hitachi Maxell that they would raise prices as well. ***Believe that if LG Chem and SDI cooperate in this, the growth of Li-Ion battery industry is likely to go in the right direction.***” The meeting minutes also detail Sony’s communication with competitors, including:

- “Sony first approached SDI before LGC regarding the price hike issue and believes that SDI would also say OK. SDI seems to be most worried about responses from internal customers rather than external customers.”
- “Sony already pushed BAJ (Battery Association of Japan), and BAJ will ask companies for cooperation through various channels.”
- “Since this is the first price hike, [Sony] want[s] all Battery companies to cooperate.”

(b) The document recounts a discussion of Sony’s plan to raise prices, despite concerns, which led them to “ask . . . LGC for cooperation. If Japanese companies, LGC and SDI cooperate on prices, expect that Chinese companies would have no choice.” The topic of SONY-Ericsson Europe follows, with Sony stating that it is going to Europe to announce a price hike in the next week, and “[a]lso hopes that LGC will raise prices of SONY Ericsson.”

(c) Under the heading “LG Chem’s Response,” the meeting minutes read:

- Mentioned that we understand SONY’s opinion enough and that we would be cooperative.

- 1 • After the Division leader returns to Korea, and discusses with
2 SDI, and would report the related policy as soon as possible.
- 3 • The reason why Executive Vice President Hong had a prior
4 meeting with our competitor SONY was to achieve cooperation
5 among companies in order for the growth of the healthy Li-Ion
6 industry. Today, rather thanked for specific cooperation request
7 for Industrial Cooperation. Delivered an opinion hoping for
8 more frequent meetings between companies and having a
9 meeting on a regular basis if possible.
- 10 • LG delivered an opinion that it wants to cooperate with SONY
11 on Polymer, and it wants to advance into Polymer along with
12 SONY because Polymer customers are negative about Single
13 Supplier.

82. On June 30, 2004, the following executives from Sony and Samsung met at the Sony Energy Company Headquarters Meeting Room:

Implicated Company	Employee Attending Collusive Meeting	Executive's Title
Sony	Nakagawa Yutaka	President
	Kamiyama Hirokazu	PCC Div. Business General Manager
	Naito Toshiaki	PCC Div. Cellular General Manager
	Katahira Taku	Marketing General Manager
Samsung	Joonghyun Lee	Executive Vice President
	Jinkun Lee	Vice President
	Yoan Oh	General Manager
	Insang Joen	General Manger
	Heeseung Yoo	General Manager

(a) Sony President Nakagawa delivered “welcoming statement,” stating that Sony was “Very close friends with Samsung. Has visited Samsung several times to discuss cooperation in memory Stick.” He stated that he was “Glad that SDI and Sony have been competitors, but *also have been able to cooperate with each other at the same time as entities participating in the same business*” and that he “Wish such a relationship would continue.”

(b) The conspirators proceeded to communicate historical and forward-looking detailed production figures for 2003, 2004, and 2005 for the “Cellular market” and the “Note PC market.” The conspirators then discussed polymer, and communicated that “Sony desires to have competitiveness in technology rather than compete through price only.” The conspirators held discussions “[r]egarding the recent Note PC market and the fluctuation of cylindrical price.” The conspirators continued that “Taiwanese pack makers have surplus stocks → Increase in production

1 capacity → Some cell makers have began [sic] to reduce the price” and that “[t]his is a risky
2 situation in that price goes down in spite of the increase in cost.” The conspirators continued that
3 “Sony is not reacting with price. *If Sony reacts with price, it will ruin the market. Therefore,*
4 *should refrain from lowering price.*” Another version of Samsung’s meeting report was translated as
5 stating, “This is a dangerous situation where cost is increasing while price is going down. Sony is not
6 responding with price. If it responds, then the market will be destroyed so price reduction must be
7 suppressed.”

8 83. Documents produced from LG’s files reflect that the minutes of *this collusive*
9 *meeting between competitors were shared with LG*, even though LG did not attend the meeting. In
10 an internal document produced from LG’s files, the same meeting is described in a June 30, 2004
11 document entitled “Sony Meeting Result Report” which recounts a meeting held between Sony and
12 Samsung SDI at Sony Energy Company meeting room. The report describes the welcome greetings
13 by Sony’s President: “*[i]t was good in that [Samsung] SDI and Sony, as competitors and*
14 *companies in the same industry at the same time, could cooperate each other, and hope that this*
15 *kind of relationship will continue.*” The report further states that “Sony’s President visited Samsung
16 several times for the “mutual cooperation on [m]emory [s]tick.” At the meeting, the companies
17 shared market information such as demand forecast for cellular phones, notebook PCs, PDAs, and
18 digital cameras, and agreed to have another meeting.

19 84. GS Soft Energy (SGS) and Sony met again on July 2, 2004, from 6:00 p.m. to 10:00
20 p.m. with SGS’s “Head of Production Planning Division GM Nakahita” attending, and they
21 communicated regarding detailed production unit figures for April and May of 2004, broken down
22 by cylindrical and “rectangular” units. The report of this meeting between Sanyo and Sony was
23 found in the files of Samsung produced to Plaintiffs – demonstrating again that even where a meeting
24 was attended by two competitors, the conspiratorial discussions were shared with their co-
25 conspirators.

26 85. On July 28, 2004, Samsung met with the following executives from Matsushita
27 Battery from 3:00 p.m. to 5:00 p.m. at Osaka Matsushita Battery: “Global Management Group GM
28 Akihiro Shimizu,” and “Global Marketing Overall Management Department GM Masaya Niko.” The

1 conspirators shared their companies' production forecasts for 2004, 2005, and 2006 and reinforced
2 that "There is no plan for cylindrical expansion in 2004."

3 86. Later on July 28, 2004, Samsung met with the following executive from GS Soft
4 Energy (SGS) from 6:00 p.m.-10:00 p.m. at a restaurant in Osaka regarding "Production
5 Headquarters Planning Department GM Kazunori Nagahataa (Kazuniro Nagahataa)." The
6 conspirators communicated regarding "SGS Capa [capacity] – Japan #2, 6, 7, 8, 9 each
7 600,000/month, #12 line 1 million/month" and "Shanghai #3,4,5 each 600,000/month, #10 line
8 1million/month" and "Polymer 500,000/month, 2 lines" and other capacity figures.

9 87. On July 29, 2004, Samsung met with executives from NEC – Tokin from 2:00 p.m.-
10 4:00 p.m. at "Tokyo NEC Energy Device Headquarters" with these attendees from NEC:

Implicated Company	Employee Attending Collusive Meeting	Executive's Title
NEC	Motohiro Mochizuki	Battery Business Department, Business Planning GM
	Taniguchi Hiromichi	Business Overall Management, Business Strategy Department
	Kazuhiko Sato	Sales Implementation Dept.
	Takashi Yoshitaka	Sales Implementation Dept.

11 The conspirators communicated various detailed forecasts, including a "Cell demand forecast" for
12 "rectangular/LIP" for 2004, 2005, and 2006," and detailed capacity information.
13
14
15

16 88. Later the same day, July 29, 2004, from 5:00 p.m. to 7:00 p.m., Samsung met with the
17 following executives from Hitachi Maxell at Tokyo Hitachi Maxell:
18
19

Implicated Company	Employee Attending Collusive Meeting	Executive's Title
Hitachi Maxell	Shigehiro Kakumoto	Energy Solution Business Group Business Planning GM
	Seiji Sumoto	B to B Sales headquarters Battery Sales GM

20 The conspirators communicated regarding various "demand forecast" projections and production
21 capacity information.
22
23
24

25 89. On July 30, 2004, Samsung met with the following executive from Sanyo Battery at
26 Tokyo Sanyo Battery from 1:00 p.m. to 3:00 p.m.:
27
28

Implicated Company	Employee Attending Collusive Meeting	Executive's Title
Sanyo	Hiroshi Noguchi	Mobile Energy Company, Strategic Business Unit

The conspirators communicated regarding Sanyo's 2003 "sales profit rate 10% range" and a "2004 sales amount 210 billion yen, sales profit 17% target." The conspirators further communicated regarding demand forecasts including a "Cell demand forecast" regarding "[r]ectangular/polymer demand for mobile phone use" and "cylindrical / rectangular" demand. The conspirators further discussed, regarding the "Toshiba takeover and SGS related," that "[a]s of June 2004, there is no change in the plan to expand rectangular 5M/month from 47M/month (cylindrical 16M, rectangular 30M, polymer 1M) Capa until the end of the year."

2. Examples of Defendants' Continued Conspiratorial Meetings and Communications in 2005.

90. On February 17, 2005, Samsung had a collusive lunch meeting with "LG VP Jang Soon Kim," and "VP Jin-Gun Lee." The conspirators communicated regarding 2004 sales volume, and regarding a "'05 1st quarter sales forecast." LG communicated that "Because of the after effect of the '04 cylindrical quality problems" that "it will be difficult to exceed 9 million cells per month from January to March '05 (around 3M cylinders, around 6M rectangles, 1M or less polymers." The conspirators further communicated regarding the "Nanjing factory operating status (cylindrical Capa: 2M/month, rectangle: 2M/month)" and details on "Polymer sales status" and an update on the expansion of two polymer lines.

91. Samsung and LG further discussed "Price Cooperation," and that "[i]n an oversupply market situation, while it is difficult to cooperate on each and every case, for certain PJTs by each customer, both companies agreed to cooperate to stand up against the Japanese business when necessary." The conspirators further discussed the "LG Chemical CEO's perspective on the battery business," including that "For the time being, look at it as if there won't be any battery facility expansion (Postponing the '05 Nanjing expansion of 8 million was a good decision)." Going forward, both companies agreed to communicate regarding price levels. Finally, Samsung's meeting notes indicate "Criticized that all the purchasing agents of HP, Dell ODMs are Spoiled."

1 92. From February 21, 2005, through February 25, 2005, Samsung met with its
 2 competitors Sanyo, Sony, Matsushita, GS Soft Energy (SGS), NEC-Tokin, and Hitachi Maxell, again
 3 discussing detailed supply and demand issues. Samsung stated internally after these meetings that
 4 “[c]ompanies are trying to refrain from adding new lines due to declining profitability and
 5 recognition of oversupply.” It further stated “[i]t is the situation of the decline of selling price and
 6 oversupply, thus, the overall situation of the industry for 2005 is expected to be difficult,” and that it
 7 ***“Requested to refrain from adding lines competitively, and each company seems to be willing to***
 8 ***refrain from adding new lines.”***

9 93. Specifically, the following executives from Samsung and Sanyo met on February 21,
 10 2005, from 4:00 p.m. to 6:00 p.m. at the Sanyo Electronics Co., Mobile Energy Company
 11 Conference Room in Ueno, Tokyo:

Implicated Company	Employee Attending Collusive Meeting	Executive’s Title
Samsung	Jong Ho Kim	Deputy General Manager, Battery Marketing Department
	Seung Won Lee	Manager, Planning Department
	Hee Seung Yoo	SDI Japan Office, General Manager
	Young Taek Cho	SDI Japan Office, Deputy General Manager
	Dong Seop Lee	Manager, Samsung SDI Japan
Sanyo	Mr. Noguchi	General Manager, Business Strategy Unit

12
 13
 14
 15
 16
 17
 18 The conspirators communicated in detail regarding production line capacity for cylindrical,
 19 prismatic, and polymer, and the “Plan to add lines” and “[f]ocusing on cost reduction rather than
 20 price.”

21 94. On February 22, 2005, the following Samsung and Sony executives met between
 22 2:00 p.m. and 4:00 p.m. at the SONY Co. Energy Company Conference Room, in Shinagawa,
 23 Tokyo:

Implicated Company	Employee Attending Collusive Meeting	Executive’s Title
Samsung	Jong Ho Kim	Deputy General Manager, Battery Marketing Department
	Seung Won Lee	Manager, Planning Department
	Young Taek Cho	SDI Japan Office, Deputy General Manager
	Dong Seop Lee	Manager, Samsung SDI Japan
	Sung Joo Park	Staff

Implicated Company	Employee Attending Collusive Meeting	Executive's Title
Sony	Mr. Nagamine	General Manager, Business Planning Department
	Mr. Aoki	Manager (Business Planning Department)
	Mr. Katahira	General Manager, Sales Department
	Mr. Ishiharada	Manager, Sales Department
	Mr. Nakayama	Manager, Sales Department

Just as before, the parties communicated in detail on a host of detailed subjects. The conspirators communicated and one or both “[r]equested that companies refrain from building additional lines.”

95. On February 22, 2005, executives with Samsung and NEC-Tokin met to again communicate regarding a host of confidential business information.

96. On February 24, 2005, executives with Matsushita and Samsung met between 3:00 p.m. and 5:00 p.m. at the “Matsushita Batteries Conference Room” in Moriguchi, Osaka to again communicate regarding a myriad of confidential business topics, including that “Matsushita has not manufactured 2.0Ah made of Mn, but will use Mn for 2.2Ah” and that it “[e]mphasized that *this is to reduce cost of materials, not to sell at low prices.*”

97. On February 24, 2005, executives from Samsung and GS Soft Energy (SGS) met at “[a] Restaurant in Downtown Osaka” between 6:00 p.m. and 8:00 p.m. to again communicate regarding numerous confidential business topics.

98. On February 25, 2005, executives from Samsung and Hitachi Maxell met between 10:00 a.m. and 12:00 p.m. at the “Conference Room in Maxell factory” in Ibaraki, Osaka to again communicate regarding numerous confidential business topics.

99. On March 14, 2005, Samsung’s “Jin Gun Lee (Managing Director, SDI)” met with LG’s “Jang Soon Kim (Managing Director, LG Chemical)” at a coffee shop between 4:30 p.m. and 6:00 p.m. to communicate regarding numerous confidential business topics. Regarding “Cell Prices,” they “Discussed pricing of 2.4Ah cell in connection with cell sold to Simplo and Dell, and asked for \$2.60.” The collusive meeting notes continue “However, participants seem to have agreed to approximately \$2.70 (SDI’s Price: \$2.80 (February)) – (will follow up).”

100. Samsung and LG met again on May 23, 2005, to communicate regarding confidential business topics.

1 101. Samsung and Sony met again on July 19, 2005, to discuss confidential business
2 topics, between 3:00 p.m. and 4:30 p.m. in Tokyo at the “SONY Corporation Energy Company 6th
3 Floor Conference Room.”

4 102. On July 20, 2005, Sanyo and Samsung met again to discuss confidential business
5 topics, between 1:00 p.m. and 3:00 p.m. in Tokyo at the “Sanyo Electric Co., Ltd. Mobile Energy
6 Company Conference Room.” The conspirators communicated that “The business got much better
7 because of the Co [cobalt] price fall, only need to save the fixed cost” and that “[f]or the sales price
8 reduction rate, planned 10% Cylindrical, 20% Rectangular.”

9 103. On July 22, 2005, Samsung again met with Hitachi Maxell to discuss confidential
10 business topics, between 9:00 a.m. and 10:50 a.m., in Osaka at the “Osaka, Ibaraki Market Maxell
11 Factory Internal Conference Room.” Defendants discussed that “Hitachi has no plans to enter the
12 Polymer focused market.” The conspirators further agreed that they “*[m]ust cooperate in terms of*
13 *control over industry* → Outsourcing is possible too.”

14 104. An internal LG document dated September 26, 2005 includes a business trip report
15 and describes an LG visit to Sanyo/MB and states: “The *objectives of these meetings were to create*
16 *direct contact points between the top managements of LG Chem and Japan’s major battery*
17 *companies, SANYO and MBI/share information.*” The report also described the purpose of the
18 meeting to “establish cooperative relationship between the Battery Association of Japan (President:
19 Mr. Ishida of MBI, Vice President: Mr. Honma of SANYO) and the Battery R & D Association of
20 Korea. The report detailed market conditions and pricing, and said “*it is the mission for the industry*
21 *to explore a new market and to avoid over-heated competition.*”

22 105. On October 26 and/or 27, 2005, Samsung again met with Matsushita in Osaka to hold
23 conspiratorial discussions. For example, with respect to “Price” the conspirators communicated that
24 “[t]here is an opinion that especially towards SMP [the packer Simplo], the current price might be
25 maintained.” With respect to “Cooperation from now on,” the conspirators “[s]uggested regular
26 meeting at the level of once every three months” with the “[n]ext time ‘06 January Seoul” and
27 further detailed the executives to contact “[i]n the case of necessary mutually urgent opinion
28 exchange.”

1 106. On November 3, 2005, Samsung and Sony executives again met, this time at the “SDI
2 Headquarter[s] Office” to discuss their collusive goals, including the “Polymer market.”

3 107. On November 14, 2005, Samsung and Sony’s executives again met to collusively
4 discuss confidential business topics. Samsung’s meeting notes reflect that the conspirators have been
5 meeting “2-3 times a year since 2004.”

6 108. On November 16, 2005, Samsung and Sanyo’s executives again met to discuss
7 confidential business topics, agreeing that “[t]rust is solidified through continuous information
8 exchange meetings with Sanyo” and discussing “SDI opinion on matters such as whether or not to
9 actively enter Cylindrical 2.0Ah.” The conspirators further discussed “[c]ylindrical high capacity
10 (above 2.4AH)” and that “For Mobile Phone: ‘05 – ‘06 demand +8~10%, selling price Δ 15%” and
11 “For Note PC: ‘05-’06 2.4Ah or more capacity products show demand +20%, selling price as Δ 10%,
12 forecast for the sole expansion in the market.” Regarding “Cylindrical Business,” the conspirators
13 communicated that “HP’s low price model 2.0Ah demand is large, but price at below U\$2.0 is a
14 problem.”

15 109. An undated document entitled “2005 – 2006 Marketing Expense Result” refers to
16 expenses incurred for numerous business meals between LG and its competitors, including Samsung,
17 MBI, Sony, and Sanyo.

18 **3. Examples of Defendants’ Continued Conspiratorial Meetings and**
19 **Communications in 2006**

20 110. On March 20, 2006, Samsung executives met with NEC executives Mr. Oyama (the
21 General Manager, Energy Devices Business Unit, Sales Department) and Mr. Omori (from the Sales
22 Department). They met from 1:00 – 2:40 p.m. on the 10th Floor of the NEC-Tokin Conference
23 Room in Chiyoda, Tokyo. The parties collusively communicated on a number of subjects, for
24 example, regarding NEC’s projected demand from customers Nokia, Motorola and Siemens, and
25 further communicated regarding NEC’s sales ranking of NEC customers including Cannon, Kodak,
26 Nikon, Olympus, Casio, and Techwin. The parties further communicated regarding the “NEC-Tokin
27 Trend,” specifically, that “Target capacity of 7.5 million units / month through productivity
28 improvement (Xiamen, China in particular) (mentioned capacity of 7.5 million units / month at the

1 Information Exchange Meeting in February 2005)” and that NEC was “Considering adding lines to
2 reach 10 million units / month by the second half of 2006 - Considering adding 1 line which is bigger
3 than the existing lines” and that “Design capacity is 7.5 million units per month. The actual
4 production volume is less than the full capacity. (5 million units sold per month as of the date of
5 meeting in February 2005).” The parties further collusively communicated regarding NEC’s detailed
6 projected production figures, broken down by “Capacity/Month (# of Lines)” for NEC lines in
7 Tochigi, Japan, Xiamen, China, and Wujiang, China. The parties further collusively communicated
8 regarding NEC’s “Plan to supply prismatic batteries to Apple (I-pod: hard disk type)” and “Entry
9 into the Polymer Battery (pouch battery) Market -0.3 million units / month per line capacity for 3
10 lines; operating in Wujiang, China.” Regarding “Plant Operation in China,” Samsung’s meeting
11 minutes reflect “There is no sale to local; through NEC corporation, sold or imported to NEC or
12 Japan.”

13 111. On August 7, 2006, Samsung again met with Sanyo to discuss confidential business
14 topics, this time in Tokyo between 5:40 p.m. and 8:20 p.m. at a “restaurant near Roppongi.” The
15 conspirators discussed their “[h]ope that the 3 companies (Sanyo, SONY, SDI) will lead the market
16 with stability with the golden section. okay to compete on technology, but refuse competition based
17 on sales price.”

18 112. On August 8, 2006, Samsung and GS Yuasa again met to discuss confidential
19 business topics, in Kyoto between 4:10 p.m. and 6:00 p.m.

20 113. On August 9, 2006, Matsushita and Samsung again met to discuss confidential
21 business topics, between 1:00 p.m. and 2:20 p.m. at the “Osaka, Moriguchi Matsushita Secondary
22 Battery Company Conference Room.”

23 114. On September 8, 2006, LG and Samsung again met to discuss confidential business
24 topics, and to communicate that with respect to “E-bidding,” “LG is very sensitive to SDI’s pricing
25 policy.”

26 115. An October 10, 2006 internal LG email with the subject line “(Important) HP Supply
27 Review meeting in Seoul” from Young Sun Kim (General Manager, LGCAI LA Office) describes a
28 meeting between LG and HP. The main purpose of HP’s visit to Korea is “to secure cell supply and

1 demand” and to discuss pricing issues. The email also refers to Samsung SDI’s previous visit to HP
2 where HP requested continued production of 2.0Ah, and Samsung SDI made it clear that it is hard to
3 continue to produce 2.0Ah starting from 2Q and that SDI will concentrate on high capacity such as
4 2.8Ah/2.6Ah/2.4Ah. The email states that as this might lead to HP’s conversion to 2.2Ah, “*please*
5 *double check SDI’s direction and check again that SDI does not cut cell prices.*”

6 **4. Examples of Defendants’ Continued Conspiratorial Meetings and**
7 **Communications in 2007**

8 116. In February 2007, a collusive meeting occurred between Matsushita (Panasonic) and
9 SDI/Samsung. The meeting appears to be triggered by a rise in cobalt prices, as cobalt is a large
10 percentage of the cost of manufacturing a battery cell. For Matsushita, Mr. Katsube and Mr. Shimizu
11 attended the meeting. Attendees for Samsung were Mr. HK Yeo; Mr. MH Jeong, and Mr. Kim. The
12 conspiratorial meeting was held in a private room at a traditional Korean barbeque restaurant near
13 the Shilla hotel, a location specifically selected because the attendees would not easily be seen by
14 others. HK Yeo of Samsung was (and is) in charge of Samsung’s office in Japan. Mr. Yeo was the
15 person primarily responsible for making pricing recommendations for cell prices to his boss, JG Lee,
16 who had the ultimate responsibility. Mr. Yeo had the responsibility to recommend pricing of cells,
17 and had pricing authority for cells used in computers and cell phones.

18 117. In this February 2007 meeting, the conspirators discussed ways they could counter the
19 increase in cobalt prices. Specifically, they exchanged forecasts of cobalt pricing, discussed their
20 concerns over the rapid increase of cobalt prices, and agreed to raise cell prices. During the same
21 meeting, the conspirators discussed using the previous three (3) month average of cobalt price
22 increases as a mechanism to be reflected in the battery cell prices for each following quarter. For
23 example, if the previous three (3) month cobalt average price increased by \$10, then the price of a
24 cylindrical cell would proportionally rise by \$10.

25 118. On February 23, 2007, Matsushita and Samsung again met to discuss confidential
26 business topics at a restaurant in Seoul “because in early February Mr. Shimizu in charge of
27 marketing at M Company [Matsushita] proposed to discuss market situation following the sharp
28 increase in cobalt price.” The conspirators communicated that “[i]n previous years cobalt price

1 skyrocketed at the end of the year and dropped in January, but the price is not dropping even now at
2 the end of February and continues to soar so there is a concern of the serious situation in 2004
3 repeating.” The conspirators further communicated their “*hope to mutually exchange the market*
4 *situation with regard to the sales price for the 2Q volume so that the business can move towards a*
5 *positive direction.*”

6 119. Samsung and Sony again met on March 14, 2007 between 1:00 p.m. and 2:30 p.m. at
7 the “Tokyo, Shinagawa Sony Meeting Room” to discuss confidential business topics.

8 120. Sanyo and Samsung again met on March 14, 2007 between 6:00 p.m. and 7:30 p.m. to
9 discuss confidential business topics.

10 121. Samsung and GS Yuasa again met on March 15, 2007 between 10:30 a.m. and 12:00
11 p.m. to discuss confidential business topics.

12 122. Samsung and Matsushita again met on March 15, 2007 between 3:00 p.m. and 5:00
13 p.m. to discuss confidential business topics.

14 123. Another incriminating email chain begins March 19, 2007 and ends March 20, 2007.
15 Samsung’s MH Jeong, the Senior Manager, Marketing Team, Energy Business Division, wrote to
16 Panasonic’s Mr. Shimizu and Mr. Katsube that “[w]e want to talk about your safety technology on
17 PRL and PSS. So please call Mr. Yeo. His Cell phone number is . . .” But in truth, Mr. Yeo has
18 nothing to do with safety technology. This email was code indicating that Mr. Jeong was asking for a
19 collusive discussion, but did not want to put in writing what it was about. Mr. Yeo, after speaking
20 with Panasonic, emailed Mr. Jeong on March 20, 2007 at 5:16 p.m. regarding the “Telephone
21 conversation with P Company” and the “Request for price increase star[t]ing this week.” Mr. Yeo
22 continued that the “Increase (Proposal)” was “Start with 10~13% increase and hope to end with
23 8~10%. (Bottom)” and that “Hope to apply to all models” and “Time to apply the increase: starting
24 from 4/1” and “Other company trend – Sanyo: hopes for 8~10% - Sony: 10% level (will end with
25 less than 10% since starting with 10%).” At 1:28 a.m. later that day, Mr. Yeo forwarded his email,
26 stating “Strictly confidential, complete security requested” to Samsung’s Ki Seop Lee, Young Hoon
27 Suh, and Won Taek Chang.

1 124. As noted above, Samsung’s Mr. Yeo reported on the content of the phone
2 conversation with “P Company” – also code (for Panasonic) and “Issue for D” – also code (for Dell
3 Computer). The email also referenced the need to get “Accept on the pack price from Company H,”
4 code for Hewlett Packard). The document mentions a concern about secrecy – this was because of
5 antitrust issues. The information received by Samsung/SDI in this document, about Sanyo and Sony,
6 came from Mr. Katsube of Matsushita. And Mr. Yeo later learned that Matsushita and Sanyo talked
7 to each other because he got a phone number for a Sanyo employee from Mr. Katsube of Matsushita.
8 When Mr. Yeo asked for Sanyo’s contact information from Mr. Katsube he was given the name of
9 Mr. Tatchihara.

10 125. An internal LG email dated May 11, 2007 with the subject line “Price-related update”
11 sent from Hee Kwan Ra (Account Manager, Battery Notebook Business, CRM Team) to
12 jhlee@popmail.lgchem.com (multiple recipients) updates the ongoing price progress between LG’s
13 customers and “S Company” and begins by stating “*please delete this email upon reading.*” The
14 email reports that Asus completed price discussions with “S Company,” but Asus asked for rebate
15 which “S Company” declined. According to the email, “S Company” asked LG to decline Asus’s
16 request as well.

17 126. An internal LG document dated June 5, 2007 entitled “SDI Meeting Report” discusses
18 a meeting held on June 4, 2007 at Yeon ChunGee, a restaurant in Korea, attended by General
19 Managers of LG and SDI, as well as Planning and Development personnel. Topics discussed at the
20 meeting included sales plans, production capacity, and “how to cooperate between LG Chem and
21 SDI.”

22 127. Not all meetings between these conspirators involved only two defendants. A
23 conspiratorial meeting between Samsung, Matsushita and Sanyo took place in the middle of June
24 2007, in the Shinagawa district of Tokyo at a restaurant. The meeting was attended by Mr. Yeo (of
25 Samsung/SDI), Mr. Tatchihara (of Sanyo) and Mr. Katsube (of Matsushita). The three companies
26 agreed to raise the price in the third quarter of 2007 using the same cobalt average price increase
27 formula. The three companies also agreed on the bottom line (a price floor) of their selling price – at
28

1 or around \$2 – \$2.30 for the 2.2 cell product. The bottom line price was achieved along with the
2 cobalt price increase in June 2007. LG Chem later also agreed to the formula and increase in prices.

3 128. A July 15, 2007 internal LG email thread with the subject line “Regarding the second
4 price increase” from Jae Min Park to Joon Ho Lee, and copied Min Jae Park and Jae Kil Kim, states
5 “Basically, Suwon/Japan’s S and M Companies increased a price by a combined 30 cents for the
6 first/second rounds in total. In the case of Suwon, the second round price increase level was 10~12
7 cents, and Japan’s S by more than 20 cents because it didn’t raise much in the first round, and
8 Japan’s M Company by 15 cents in the second round.” On information and belief, “Suwon” refers to
9 Samsung, “Japan’s S” company refers to Sony or Sanyo, and “Japan’s M Company” refers to co-
10 conspirator Matsushita.

11 129. On July 15, 2007, a series of email exchanges between Joon Ho Lee (VP, in charge of
12 Battery Notebook Business), Jae Min Park (Senior Manager, Battery Notebook Business, CRM
13 Team) and Jaegil Kim share price increase information of “Suwon’s S Company,” “Osaka
14 Company,” and “Japan’s M Company,” such as level of price increase. The email from Joon Ho Lee
15 states, “in the July 7 meeting with Suwon Company, we checked that Osaka Company and M
16 Company across the sea are already conducting the second round of price increase and also that
17 Suwon Company also began the work last week.” On information and belief, “Suwon S Company”
18 refers to Samsung, “Osaka Company” refers to Sanyo as its headquarter is there and “Japan’s M
19 Company” refers to co-conspirator Matsushita.

20 130. A September 27, 2007 internal LG email thread with the subject line “Fw: (Important)
21 Bosch RFQ strategy” from Jae Min Park to Yong Wook Chung discusses pricing and production
22 information gathered from Bosch. Jae Min Park concludes the email with “*[f]or more exact model*
23 *prices, I will share with you tomorrow after the final discussion with S Company. . . .*”

24 131. An October 5, 2007 internal LG email with the subject line “Bosch Price,” from Yong
25 Wook Jung to Joon Ho Lee states, “The price agreed with Manager Moon of SDI Frankfurt is as
26 follows: SDI 1st G: 2.10-2.20 . . . 2nd G: 2.30-2.40 (the same as above) LG Chem 2nd G: 2.29 USD
27 (supply 2nd G only, the bottom price is 2.25 USD) SDI is 16:00 on 9th, and 15:15 on 10th. –End-”
28 SDI refers to competitor Samsung/SDI.

1 132. On November 30, 2007, Jae Min Park told Joon Ho Lee in an internal LG email with
2 the subject line “Customer Meeting,” that “In regards to an S Company meeting, S Company
3 informed me that is it uncomfortable attending a meeting due to company internal issues and that is
4 would contact soon.” Mr. Lee responded to Mr. Park on December 2, 2007, “As far as I was able to
5 find out, they seem to be under a *special investigation by the Prosecutor’s Office*. As an external
6 explanation, they are saying that they are restraining from contacts with other companies due to Fair
7 Trade Commission’s investigation, *which sounds to be somewhat of a lame excuse.*”

8 **5. Examples of Defendants’ Continued Conspiratorial Meetings and**
9 **Communications in 2008**

10 133. A January 26, 2008 email thread between Jae Min (“Jerry”) Park from LG and
11 Ushiyama Naoyuki from Sony in Japan discussed a meeting that they attended in Taiwan, and
12 potential future meetings. Park emailed Naoyuki on January 25, 2008 to introduce himself as the
13 person “in charge of cylindrical cell sales biz in LG Chem.” Park refers to a meeting they previously
14 had in Taiwan, and states that the “reason I sent the email to you suddenly is I would like to meet
15 you again and exchange the market information for each other biz.” Park further states that he “will
16 visit Tokyo from 28th, Jan to 30th, Jan. If you are available in this period and O.K. to meet us, I
17 would like to meet you in any place in Tokyo.” Naoyuki responded he “will be available at 11:00-
18 12:00 on Jan. 29th at our HQ in Shinagawa.” Park accepted the invitation to meet at the headquarters
19 in Shinagawa on January 29th, and listed LG’s attendees: “John Lee (Sales, VP), Jerry Park (Sales,
20 GM), and Paul Kwon (Sales, Japan account manager).” Park stated he would contact Naoyuki again
21 before the meeting, and provided him with his mobile number in case Naoyuki needed to reach him.

22 134. A January 28, 2008 internal LG document entitled “SANYO Meeting Minutes”
23 describes a meeting held that day at Narita Airport between LG executives and “General Manager
24 Ikegami (GM, overseas biz)” of Sanyo during which they discussed future exchanges of market
25 information, customer demand, capacity, pricing, and agreeing that information bearing on prices
26 and production costs should “*not be opened to the customers.*”

27 135. A January 31, 2008 email with the subject line “Meeting Minutes regarding ‘SA’
28 meeting,” from Jae Min Park (Senior Manager, Battery Notebook Business, CRM Team) describing

1 the same meeting referenced above, attended by LG and Sanyo, which took place on January 28,
2 2008 at Narita Airport. The email begins by saying “regarding this matter, *please delete it upon*
3 *reading.*” At the meeting, the companies exchanged market information and discussed demand, SA’s
4 capacity, and prices. As for continued collusive discussions, LG “*made suggestions of consistent*
5 *[m]arket information exchanges in the future, and ‘Sa’ also showed positive response.*”

6 136. In a February 11, 2008 email with the subject line “About price adjustment,” LG’s Jae
7 Min Park, wrote to LG’s Jae Kil Kim, and copied Joon Ho Lee, and stated that “Regarding
8 cylindrical cell price increase, things are going as below. Please take into account. – Effective date:
9 3/1 (March/April/May) – Price increase: by 10% minimum – Suwon S Company’s Rationale:
10 Although the Co[balt] Price was \$30 in the past increase, Co price of \$40 is applied to the months of
11 March/April/May (three months). Therefore, it is inevitable to increase the price at least by 10%.”
12 LG’s email regarding S Company continued, stating “Considering current Co[balt] price increase, it
13 plans to mention in advance that additional price increase is unavoidable for June/July/August (three
14 months). (\$40->\$50).” LG continued that “Therefore, it [S Company] plans to raise price twice, first
15 by at least 10% for March/April/May, and second by at least 10% for June/July/August . . . LG
16 Chem, after Suwon S Company completes notification, will also notify its customers of the price
17 increase, and start to apply from March 1.”

18 137. A February 27, 2008, internal email thread from Jae Kil (“Albert”) Kim to Joon Ho
19 Lee advised Lee of the status of price increases, and the pricing implemented by competitors
20 including Samsung SDI, Sony, and Sanyo. Joon Ho Lee responded “Members in the office in
21 Taiwan, You did a good job.” In response to Lee’s email Jae Min Park reported “*Today, I received*
22 *[a] call from Suwon to reconfirm the price increase, and [I] Suwon said that it does not have any*
23 *problem with raising the price according to the contents mentioned last time.* LGC also asked for
24 support. Regarding this, LGC mentioned that they shouldn’t be worried about it because LGC is
25 aimed to carry out in addition to what was mentioned last time. General Manager Kwon, Sang Cheol
26 asked me to explain the contents of the price increase. I would appreciate if Vice President gave me
27 your opinion whether I am allowed to open the contents to him.” On information and belief,
28 “Suwon” refers to LG’s competitor, Samsung/SDI.

1 138. On February 27, 2008, LG executives met with General Manager Ikegami of Sanyo at
2 the Akasaka restaurant. Among other things, they discussed production, capacity, customer
3 information, future pricing information, and efforts to keep information from their customers
4 concerning their pricing strategies and costs of production.

5 139. An internal LG document entitled, “SA’ Company Minutes” (Sanyo is later
6 identified as the meeting participant) describes a meeting that took place on February 27, 2008 at the
7 Akasaka restaurant. Attendees from LG were Joon Ho Lee (VP, Notebook Business), Deuk Yong
8 Kwon (Notebook CRM Team); in attendance from Sanyo was Mr. Ikegami (General Manager,
9 Overseas Business). They discuss capacity issues, and the need to check on competitors’ production
10 plans (Sony, MBI). Next to the section labeled “Regarding Price,” it says:

- 11 • Check Sanyo’s price increase logic
- 12 • The price increase, this time around, reflects price hikes in raw
13 materials including Cobalt, but did not mention the specific
14 logic.... Regarding price increase, need to deliver a message
15 again that the formula should not be open to customers.
- 16 • Expressed positively to LGC’s proposal, but mentioned
17 indirectly that it’s not easy for [Sanyo] not to open the formula
18 because of strong request of customers....Discuss the timing of
19 the second round of price increase.
- 20 • Regarding LGC’s mention, did not say specific yes/no opinion,
21 but gave just a basic answer that they would raise prices if they
22 need to reflect increase factors.

23 The companies discuss production capacity, product development, and relationships with various
24 packers. In conclusion, LG notes that Sanyo says it “want[s] to maintain a communication channel
25 with LGC in the future, and requested this meeting with the intention of maintaining continuous
26 communication.”

27 140. A March 5, 2008 internal LG email circulated a February 29, 2008 meeting minutes
28 report that LG executives met with General Manager Matsumoto of Panasonic to discuss production
capacity, customer information and a plan to increase prices. During the meeting it was confirmed
that prices would be increased, and that LG would follow up with General Manager Matsumoto
during the week following the meeting “regarding the price increase level.”

1 141. A May 13, 2008 internal LG email thread with the subject line “(revised) ‘M’
2 Company meeting minutes,” which attaches meeting minutes, contains an email from Joon Ho Lee
3 (VP, in charge of Battery Notebook Business) describing a meeting held on May 9, 2008 between
4 Joon Ho Lee, Deuk Yong Kwon of LG and General Manager Matsumoto of “M” Company at the
5 Ana Hotel in Tokyo. The companies discussed capacity and price and proposed “to take a common
6 or cooperative line toward customers.” Lee also asked Assistant Manager Kwon to “immediately
7 create the Toshiba Supplier Meeting Summary.” The meeting minutes attached to the email also
8 states that “General Manager Matsumoto plans to visit Korea in the second week of June (An
9 additional meeting with LGC is planned). When it comes to the detailed information of each
10 company, promised to exchange information between the two over the phone.” On information and
11 belief, “M Company” refers to co-conspirator Matsushita.

12 142. On May 16, 2008 at 1:14 p.m., LG’s Joon Ho Lee emailed LG’s Jae Min Park and Jae
13 Kil Kim, and copied LG’s Sunghwan Kim, Heekwan Ra, Byung Ung Jang, and Jung Won Lee, and
14 stated “I would like to share the following information acquired from SDI. . . . (Please share the
15 following[] with overseas branch offices and local members as well as with other related departments
16 within the Division, if necessary.) – Planning to increase prices in June (approximately by US
17 \$0.16/Cell) – (Regarding this price adjustment, SDI shared information about Sony’s movement and
18 agreed that it would lead the price increase.)

19 143. LG’s Mr. Lee continued that “There was a proposal for setting up a dinner meeting
20 with our division leader (with Senior Vice President JS Lee) around June, and both companies
21 exchanged opinions on strengthening working-level employees cooperation. To team leader Mr. Park
22 . . . please check the information about the current communication channel with SDI, and also the
23 June price increase. I wish that the Taiwan branch office will also figure out the movements of . . .
24 other Cell Makers and share the information.”

25 144. A June 11, 2008 internal LG email thread with the subject line “(Taiwan Office)
26 Report on competitors’ price increase,” Sang Woo Kim (Manager, Battery Sales Team) reported
27 internally about planned price increase by LG’s competitors including Sony, Samsung SDI, MBI,
28 and Sanyo. Jae Kil Kim (Senior Manager, Battery Notebook Business, CRM Team) also describes

1 three options in terms of timing of LG's price increase and concludes that "it might be better to join
2 other companies' price increase."

3 145. An internal LG document contains meeting minutes of an August 8, 2008 meeting
4 between LG and Panasonic at the Lexington Hotel, attended by Joon Ho Lee, Jae Kil Kim and Deuk
5 Yong Kwon of LG, and General Manager Matsumoto of Panasonic. At this meeting the conspirators
6 shared information about capacity, customer status and battery market outlook, price, Panasonic's
7 customer strategy, SDI's entry to Japanese makers, 4Q price, verified information by each customer
8 and others. The minutes further state that "LG asked for a meeting with a person in charge of
9 Panasonic's power tool, and Panasonic mentioned that it would set up a meeting if there is an
10 opportunity."

11 146. An August 12, 2008 internal LG email with the subject line "(Sharing) P Company
12 meeting minutes" from Deuk Yong Kwon (Manager), attaching a document entitled "'P' Company
13 meeting minutes" states "*[p]lease delete the attachment upon reading.*" On information and belief,
14 "P Company" refers to co-conspirator Panasonic.

15 147. A September 4, 2008 internal LG email with the subject line "Market information
16 080904" from Joon Ho Lee (VP in charge of Battery Notebook Business) shares information
17 acquired regarding [Samsung SDI]'s current line status, production information, and pressure on
18 [Samsung SDI] from one of its customers for price cut. Also mentions Osaka S Company's current
19 status with [Toshiba] and L companies in Japan with respect to price adjustment. The email also
20 states that [Samsung SDI] plans to have a series of opinion exchanges with overseas companies.

21 148. A September 11, 2008 internal LG email with the subject line "Market information"
22 from Jung Han Park (Manager, LGCAI NY HQ) reports one of LG's customer's pressure on LG for
23 price cut and states that "LGC too will have to discuss changing market dynamics with [Samsung
24 SDI] and others, and prepare our official position. . . ."

25 149. A September 29, 2008 internal LG email thread with the subject line "Report on HP
26 price adjustment plan," from Joon Ho Lee discusses "double-check Sanyo's price decrease level,"
27 and refers to Samsung SDI and its planned price cuts and ranges. In an effort to remain discreet, Lee
28

1 directs recipients ***“From now on, when you create a document, let’s omit the cover page if possible.***
2 ***Simplicity is the best.”***

3 150. On October 10, 2008, representatives of LG met with Sanyo at Narita Airport to
4 discuss capacity, market plans, pricing to customers, and expected price trends.

5 151. An October 13, 2008, internal LG email with the subject line “Market Information
6 081013,” and attaching Sanyo meeting minutes, from Joon Ho Lee stated “As attached, I am
7 reporting to you what was discussed in the last week’s meeting with Sanyo, based in Osaka, Japan,
8 and Sales Person-In-Charge.” Lee further stated, ***“We exchanged opinions on preventing activities***
9 ***to destroy price mechanism within the market, and for that matter, both are willing to maintain***
10 ***and expand company-to-company communication about related market information.”*** Lee
11 concluded his report stating ***“P.S. Please make sure that each related personnel takes a look at this***
12 ***email and delete it.*** If you let me know what needs to be verified, I will check the information and
13 share it with you.”

14 152. An October 12, 2008 internal LG email with the subject line “Report on the business
15 trip to Japan,” from Min Ho Chung (Senior Manager/Marketing, Mobile Energy Division) to Joon
16 Ho Lee attaches detailed minutes from meetings with Japanese battery makers, Sanyo and Panasonic.

17 (a) The Panasonic meeting took place on October 8, 2008 in a meeting room at a
18 hotel in Osaka. Panasonic participants included General Manager Shimizu (Marketing), Manager
19 Kondo (Business Planning) and Takagi (Prismatic Sales-Nokia). They discussed general business
20 plans, market status, customer demand, forecasts, and specific products. The document reflects
21 exchanges regarding extension plans and other companies in the market. LG and Panasonic made
22 agreements to limit technology development:

23 LGC) In the process of each company preparing Post 3.0Ah
24 individually, if companies go in a different development direction . . .
25 in the future, there is a concern that suppliers would be divided in
26 several groups or one company might go its own way. Therefore the
industry needs to minimize development resources and risks through
reaching a consensus for Post 3.0Ah development by actively using
outside conferences.

27 Pana) It totally consents to that. It needs to find a way for that.

1 (b) A meeting with Sanyo took place October 9, 2008 in a meeting room at a hotel
2 in Tokyo. General Manager Noguchi (Marketing/Business Strategy) from Sanyo participated. The
3 conspirators discussed many of the same topics as were discussed with Panasonic at the October 8,
4 2008 meeting: forecasts, customers, demands, product development, as well as more concerns about
5 Chinese company ATL. The conspirators also discussed Cylindrical capacity and sales, with 2009
6 “expected to be the 1:1 competition between Sanyo and SDI.” The meeting appears to close with a
7 similar agreement on future product development as with Panasonic:

8 LGC proposal) Regarding the development direction after 3.0Ah, in
9 order for both companies or the industry to avoid the risks;

10 1) it is needed to share development direction of the industry as a
11 whole through conferences, or

12 2) to secure a consensus on the basic development direction between
13 Sanyo and LGC (it was discussed with the director of BTC before the
14 business trip)

15 Sanyo) Until now, the basic direction was the same so it has been done
16 individually. It has the same idea that there is a need for cooperation
17 regarding the difficult issues...which [are] hard to make a decision
18 alone.

19 Sanyo) ‘Do you think SDI has the same idea?’

20 LGC) If necessary, we will find out what SDI is thinking.

21 Sanyo) We will report this to the CEO and ask his opinion.

22 Note) This is perceived that in cooperation, the 2 Korean companies
23 are more possible than the Japanese companies (because the
24 development direction is same or it’s easy to check information.)

25 The meeting concludes with Sanyo expressing that it “[k]nows that recently, [capacity] of separator
26 makers is insufficient, but fortunately, due to good relationship with Asahi, Sanyo is supplied first.”

27 153. An October 13, 2008 internal email with the subject line “Market Information
28 081013” attaches “SA Company Meeting Minutes.” Joon Ho Lee (VP in charge of Battery Notebook
Business) internally reported about the meeting held on October 10, 2008 with Japan’s Osaka S
Company at Narita Airport. Topics discussed at the meeting included line extension, production
capacity, and price strategies for each of its customers. The companies “[e]xchanged opinions on
preventing activities to destroy prices within the market” and agreed to “maintain and expand

1 appropriate company-to-company communication about related market information.” The email
2 continues “*[p]lease make sure that each related personnel takes a look at this mail and delete it*
3 *immediately.*”

4 154. An October 28, 2008 internal LG email thread with the subject line “Powertool
5 weekly report,” Joon Ho Lee (VP, in charge of Battery Notebook Business) internally shared
6 information “acquired yesterday regarding the [power tool] business of [Samsung SDI],” stating that
7 the information will be used for LG’s future power tool business strategy. The email describes
8 production information and power tool customer information.

9 155. A November 12, 2008 internal LG email with the subject line “(Sharing) Phone
10 conversation with Sa,” from Deuk Yong Kwon, reports “I received a phone call today from General
11 Manager I from S Company in Osaka, Japan, and I would like to share briefly what I checked with
12 General Manager I.” General Manager I contacted Mr. Kwon because Lenovo China had contacted
13 “S Company” to request a price cut. General Manager I told Mr. Kwon that S Company would not
14 cut prices, and asked LG to support S Company in refusing to cut prices. On information and belief,
15 “S Company” refers to co-conspirator Sanyo. The email also describes a discussion about pricing
16 strategy to other customers.

17 156. An undated document entitled “NEC-Tokin Meeting” recounts a meeting held on
18 December 5, 2008 between LG and NEC-Tokin at a NEC-Tokin meeting room in Tokyo. At the
19 meeting the companies discussed battery business trend of the digital cameras and game devices
20 markets and NEC-Tokin’s production capacity and product roadmap.

21 157. A internal LG document titled “Panasonic Minutes (December 8)” recounted a
22 meeting between Panasonic and LG on December 8, 2008 in Osaka, Japan, attended by Vice
23 President Joon Ho Lee (in charge of laptop business) and Deuk Yong Kwon (the laptop CRM 2
24 team) of LG and Panasonic General Manager Matsumoto (Team leader of Cylindrical sales) and
25 Katsube (overseas sales Part leader) of Panasonic. The conspirators discussed production, capacity,
26 supply and demand trends, and coordination of pricing to customers.

27 158. In a December 10, 2008 internal LG email from Joon Ho Lee to Jeong Han Park, Jae
28 Min Park, and copied Jae Gil Kim and Jeong Oh Kim, with the subject line “Executive Vice

1 President's U.S. business trip," Lee discussed plans to raise prices to HP, and describes Samsung
2 SDI's plans to submit new pricing to HP, when it would be submitted, and what the prices were
3 expected to be.

4 **6. Examples of Defendants' Continued Conspiratorial Meetings and**
5 **Communications in 2009**

6 159. A January 6, 2009 internal LG email with the subject line "Content checked by P
7 Company," from Deuk Yong Kwon to Joon Ho Lee recounted discussions between LG and
8 Panasonic about future pricing to customers for lithium ion rechargeable batteries and strategies to
9 "defend the selling price" in the face of declines of production costs.

10 160. A February 12, 2009 internal LG email with the subject line "Report on Japanese
11 makers' trends," from Jang Won Huh (Assistant Manager, Global Battery Marketing Team) to Joon
12 Ho Lee, attaches a report on information from Japanese companies. Mr. Hun wrote "I am reporting
13 the recently acquired information on 3 Japanese competitors (Sanyo, Sony, Panasonic). . . ." Major
14 customer demand forecasts are exchanged and compared, as are production development plans for
15 future technologies, such as car batteries.

16 161. An April 7, 2009 internal LG email with the subject line "Market Info 090407," to
17 Min Ho Chung, Jae Kil Kim and Hee Kwan Ra from Joon Ho Lee (VP, in charge of Battery,
18 Notebook Business) shared "information obtained regarding the grand mansion S across the sea. . . ."
19 The email to S Company's line expansion plan, pricing plan, and its plan for merger with P
20 Company. The email ends by stating "*please delete as soon as possible.*" On information and belief,
21 "S Company" refers to Sanyo and "P Company" refers to Panasonic.

22 162. A May 14, 2009 internal LG email with the subject line "Report on D Company's
23 April performance (compared with LGC)" from Young Moon Riew attaches an excel file entitled
24 "LGC v. SDI Comparison of 2009 Sales," which includes Samsung SDI's sales performance by
25 product and customer from January to April 2009.

26 163. An October 16, 2009 internal LG email from General Manager Min Ho Chung
27 exchanges information acquired from Panasonic and Sanyo during meetings, which took place July 8
28 to 10, 2009, as well as information regarding "yesterday's phone conversation content regarding

1 Panasonic's cylindrical cell extension." Chung reported "Japanese companies still internally question
 2 about going for 6.5-7M/Month scale, unlike Korean companies." A chart was attached to the email
 3 comparing cell makers and customers' cell demands. Also attached were the meeting minutes
 4 between LG and Panasonic, which reflected discussions of production forecasts, customer demand,
 5 pricing goals, potential extensions, and various products. The email also attached Sanyo meeting
 6 minutes which included a discussion of Panasonic's acquisition of Sanyo stating "The U.S.
 7 government is opposed to the Pana's pushing for acquisition due to the monopoly and oligopoly
 8 issue of the NiMH business." The conspirators compared LG and Sanyo's demand forecasts and
 9 plans for product development. The minutes also include a section for "The talk result between
 10 LGC's purchasing director and the division leaders of Asahi kasei and Hitachi kasei (July 9,
 11 Manager Choi in Tokyo)."

12 **7. Examples of Defendants' Continued Conspiratorial Meetings and**
 13 **Communications in 2010**

14 164. A March 12, 2010 internal LG email with the subject line "[Notice] Business leader's
 15 instructions regarding SMP 2Q price," from Jung Won ("Justin") Lee provided a report/meeting
 16 minutes from a March 10, 2010 pricing negotiation/meeting with SMP (packer Simplo). Target and
 17 offer prices were exchanged between the two, and LG "checked various roots" to confirm suspicions
 18 it had about SDI's offer. There was a section in the notes that listed competitor offers to Simplo (next
 19 to the heading it read, "(content checked through PM)"). Under the accompanying chart, was a note,
 20 "SDI/Sony/Sanyo are discussing again." The notes explained that "it is a situation where responding
 21 with the price at the same level as SDI for 2.6Ah and in between MBI/SDI for 2.2Ah is desperately
 22 needed in a position to discuss with SMP." Several "New Bottom Line (Price[s])" are also listed,
 23 noting position amongst competitors. Another section, "Business leader's instruction," states,

- 24 1) Ambiguously say D Company's [SDI] price, which was
 25 identified by contacting D Company's General Manager "Yeo"
 26 before today's meeting, and check whether it is true or not.
 27 2) Considering the symbolic value of SMP price in the Taiwanese
 28 market, strongly Appeal that the prices of other companies can
 ultimately become similar and it can grow into the pack price
 battle, and ask back at the same time.

- 1 3) Do not propose the Bottom line price from the beginning, but
2 propose to the Bottom with some time gap, and when there is a
3 wide divergence of opinion, prepare for the long-running battle
 by earning time, not thinking about ending it today.

4 165. A March 18, 2010 internal LG email thread with the subject line “FW: (Sharing &
5 Reporting) SMP 2Q price discussion” from Jae Kil (“Albert”) Kim provides further information on
6 the March 10 SMP meeting. Before presenting the information, Sung Hwan Kim wrote, “[b]elow is
7 what has to be shared & reported on about the outcome of SMP price negotiation.” Detailed notes
8 and charts follow, including a section under a price chart called “Background to above prices and
9 situation of competitors.” Contained in this section is detailed competitor information such as SDI
10 contracts, sales forecasts, and price information. One notable portion reads:

11 Was told that LGC prices of 2.2Ah&2.6Ah were higher than [SDI] and
12 was asked to make price cuts at the same level, so requested prices of
13 domestic competitors and was able to check them exceptionally (by
 competitor e-mail, A strict embargo on releasing this piece of
 information is very much appreciated except for the recipients of this
 e-mail.)

14 166. A September 14, 2010 internal LG email thread with the subject line “Apple line
15 allocation for Apple – K93 price response” from Yongsun Kim includes detailed information on
16 Apple negotiations, LG and SDI. On information and belief, “K93” refers to Apple’s tablet, the iPad.
17 The email thread also refers to several meetings between the competitors. The email thread
18 demonstrates an arrangement between SDI and LG regarding allocating sales to Apple. One email to
19 LG Vice President Yong Wook Chung from Young Sun Kim, General Manager, states that after
20 “checking [with] SDI today . . . it would be better just to observe the progress” regarding an Apple
21 deal. Another message from Kim explains, “[b]ased on LGC’s logic, prices should be matched. . . .
22 [W]e need to consider action plans after checking competitors’ information once again.”

23 167. On November 5, 2010, Min Ho Chung emailed Daeil An, Young Sun Kim, Yoo Sung
24 Oh, Sang Woo Kim and Yong Chan Kim a report with the subject line “Movement of SDI.” Chung
25 wrote: ***“Please use this for your information to grab an idea of the current situation, and a strict
26 embargo on resending it is requested.”***

27 168. On November 15, 2010, Dong Woo Lee followed up: “Talked to Senior Manager
28 Park Jong Seon of SDI sales (used to be in charge of Apple) who has been seconded to Cupertino

1 Office since last week, over the phone today, but couldn't talk long as he is now on a business trip. It
2 is likely that we can meet and talk properly once he comes back to Cupertino." Lee then added what
3 was discussed over the phone: "1) [h]ave been asked recently to increase volume, like us, regarding
4 K93; 2) [h]ave been requested for supply of 2M/M or more ([s]eems to be more than that); 3) and it
5 is also difficult for SDI to deliver all the requested volume; [w]as told that it had been thought that it
6 would be impossible to supply all since Apple does over forecast every time, regarding too much
7 total volume." Next day, Lee updated his previous mail by stating, "Was told that the business trip
8 site is currently Atlanta, fyi."

9 169. In late 2010, Samsung and LG, including directly through LG's San Jose, California
10 office, in furtherance of Defendants' conspiracy, expressly agreed on price levels to be charged for
11 sales to Apple computer relating to Apple's iPad. Specifically, on December 1, 2010, at 5:03 PM,
12 LG Chem America, Inc.'s Dong Woo Lee, a/k/a "Don Lee" or "Donny," emailed several LG
13 executives from his San Jose, California office located at 2450 N. First St. #400. He wrote to Young
14 Wook Chung a/k/a (Andrew (Y.O.) Chung) and four others that, regarding "K93 related information
15 – D Company Meeting," that "I update the mutually shared K93-related information [meaning iPad
16 information] at the meeting with D Company [meaning Samsung SDI America] today. 1. Price: \$
17 0.42~43/Wh range. We said that our price is a little bit higher than \$0.38, and told them not to cut the
18 price since we currently plan to increase the price to \$0.42 level."

19 170. LG's Yong Wook Chung wrote back that same night to Dong Woo Lee in San Jose, at
20 12:37 a.m., copying also LG's Young Sun Kim, Sung Jun Cho, Jung Ho Yoo and Hyunhwa Kim,
21 stating "It's good information. Please send me the feedback after identifying if they [Samsung] can
22 move in the same price range." LG's Young Wook Chung further wrote that same day, "We plan to
23 go ahead with at least \$0.50, and the counterpart's [meaning Samsung] vice president Oh, Yo Ahn
24 agreed on this, so please try to create the same kind of feeling with the counterpart, and never make a
25 sound in doing so."

26 171. LG's Mr. Chung wrote again that same day to Dong Woo Lee in San Jose, stating that
27 "We said that we would raise the price at least by 10% from the existing price, and they [Samsung]
28 also promised to commit."

1 **8. Examples of Defendants’ Continued Conspiratorial Meetings and**
2 **Communications in 2011**

3 172. A February 16, 2011, internal LG email sent by Jae Min Park relays information he
4 gathered at a “Quality Summit” regarding a February 18 HP e-bidding auction and bidding positions.
5 He reports that “STL/SDI is not interested. SMP will try to secure at least No. 2 position....It is
6 expected that DNP is trying to secure No. 1 or No. 2 position. We have not checked Sanyo’s case.”
7 Park goes on to explain LG’s strategy for “minimize[ing] a pack price decrease” and “maximize[ing]
8 profitability through raising cell prices for all packers....” He concludes by saying he will call with
9 more information.

10 173. A March 3, 2011, internal LG email thread with the subject line “(CRM 1 Team)
11 Competitor’s trend on Q2 cell prices for packers, from Jae Min Park discusses information regarding
12 SDI’s price increases.”

13 174. A March 22, 2011, internal email from LG’s Paul Kwon shares information regarding
14 “Sanyo[’s] supply status after the Japanese earthquake.” Kwon writes that this information was
15 received via phone call with “General Manager I in HK today.”

16 **B. The U.S. Subsidiary Defendants Directly Participated in the Conspiracy**

17 175. The U.S. Subsidiary Defendants participated in Defendants’ collusion regarding
18 Lithium Ion Batteries in several ways, including by (1) directly colluding with competitors; (2)
19 employing executives who were involved in conspiring with foreign competitors; and (3) acting at
20 the Foreign Defendants’ direction as to pricing and supply decisions of the U.S. Subsidiary
21 Defendants for U.S. customers in furtherance of the conspiracy.

22 176. With respect to categories (2) and (3) in the preceding paragraph, the Foreign
23 Defendants’ executives, including those who participated in collusive meetings while in their
24 positions at the Foreign Defendants, were routinely dispatched, seconded or sojournered to the U.S.
25 Subsidiary Defendants to conduct the business of the subsidiaries, and engaged in collusive conduct
26 while at those subsidiaries. Those foreign executives had actual and apparent authority over pricing
27 decisions that were carried out through U.S. Subsidiary Defendants. In other words, the foreign
28

1 executives dictated, controlled, set, directed and/or directly influenced the prices that their U.S.
2 Subsidiary Defendant counterpart sold Lithium Ion Batteries in the U.S., to U.S. customers.

3 177. Moreover, to ensure adherence to the conspiratorial understanding between
4 Defendants, foreign executives exercised their pricing authority through direct discussions with U.S.
5 Subsidiary Defendant personnel. Without doing so, the Defendant conspirators could not have
6 successfully achieved their unlawful objective of restraining price competition for sales of Lithium
7 Ion Batteries.

8
9 178. The foreign executives' relevant pricing communications with U.S. Subsidiary
10 Defendants' personnel occurred before, during, and *after* the foreign executives participated in the
11 secret, conspiratorial meetings and communications detailed herein. The foreign executives thus
12 knowingly and necessarily carried out the conspiracy through the employees of the U.S. Subsidiary
13 Defendants to successfully implement the Foreign Defendants' unlawful plan.

14 179. The foreign executives therefore legally and factually directed the U.S. Subsidiary
15 Defendants to set conspiratorially inflated prices for Lithium Ion Batteries.

16
17 **1. LGCAI's Participation in the Conspiracy**

18 **A. LGCAI's Direct Communications Regarding the Conspiracy**

19 180. LG Chem America, Inc. ("LGCAI") directly participated in collusive communications
20 on numerous occasions. For example, on October 25, 2005, LGCAI's Yoo Sung Oh, from its Austin,
21 Texas location, wrote LGCAI's Young Sun Kim in its San Jose, California location, and told Young
22 Sun Kim that it was important to collaborate with Defendant SDI in negotiating prices to packer
23 Simplo, and that "they have to watch SDI offer prices in negotiating with Simplo."

24 181. On September 7, 2006, LGCAI employees were involved in an email string detailing
25 collusive communications between LG Chem Korea and SDI Korea. On September 7, 2006, in an
26 internal LG Chem email string between employees of LG Chem Korea and LGCAI, meetings
27 between LG Chem Korea and SDI Korea are detailed, including a report that the companies agreed
28 to no longer compete on price, and the need to establish prices for Q4 2006. All recipients were

1 invited to then attend the “Q4 pricing call,” including employees from both LG Chem Korea and
2 LGCAI.

3 182. Also on September 7, 2006, LGCAI’s Yoo Sung Oh, from LGCAI Austin, Texas, was
4 included in an email string reporting on collusive communications between LGC Korea and SDI
5 Korea. In an email from Jae Min Park (LGC Korean HQ Senior Manager) to Jae Kil Kim (LGC
6 Taiwan) and Yoo Sung Oh, Park reported on a dinner meeting with SDI’s HK Yeo at SDI Korean
7 HQ, and that the discussion included that there should be “**no occasion anymore where both**
8 **companies hurt each other through further price cuts.**”

9 183. On an email chain among LG personnel spanning between March 7, 2007, and March
10 21, 2007, LGCAI’s Yoo Sung Oh, from its Austin, Texas office was included. The email chain
11 discusses a Sanyo price increase notification. An included email from March 16, 2007 from LG’s JH
12 Lee stated that “For your reference, there is a movement where the Korean S Company is trying to
13 carefully raise prices with Japan’s M Company. In the circumstance where we were observing the
14 situation since they tapped our opinion last week, it seems that Japan’s S company first carried it out.
15 . . . It is believed that now is a situation where all the Korean companies cannot decrease prices while
16 there is a need to realize additional profits in the battery business.”

17 184. On March 27, 2007, LGC Korea’s Jae Min Park, Senior Manager of Battery
18 Notebook Team, gives directions to LGC Team (including employees at LGCAI) on pricing to
19 customers such as Dell and HP. Jae Min Park also emailed Yoo Sung Oh (LGCAI, Dell Account
20 Manager in Austin, TX), and told him that with respect to concerns about packers lowering prices to
21 HP and Dell, “*[t]oday (March 27), [we] discussed with SDI [and] decide to maintain the 2Q pack*
22 *price for Dell.*”

23 185. An April 2, 2007 email chain indicates that LGCAI is involved with checking
24 competitor prices at the request of LGC Korea, and employees of LGCAI were involved in the email
25 string reporting on LG Chem Korea’s collusive communications with SDI Korea. LGC Korea’s Joon
26 Ho Lee emailed LGCAI’s Young Sun Kim (LGCAI) discussing the e-auction result of bidding for
27 the HP contract. Lee suggested that the auction bidding resulted in LGC losing the bid. As a result,
28 Lee instructed: “please make sure that the U.S. and Taiwan check in details the bidding prices of the

1 top 3 companies and what's the plan about how to meet the cost structure in the future. LGC Korea's
2 Jae Min Park then emailed LGCAI's Jung Han Park: "With regard to competitors' prices, please
3 share what was checked in the U.S. Office/Taiwan Office, and first, when sharing competitors'
4 prices, please limit the recipients to the people on this mail's recipient list."

5 186. In a May 31, 2007 email from LGC Korea's Jae Min Park to LGCAI's Jason Park aka
6 Jung Han Park regarding Defendant SDI's "line status," JM Park reports the status for each line and
7 SDI's total supply volume to HP and that "talked over the phone with S Company's Group Leader,
8 meaning, on information and belief, SDI.

9 187. In a May 2008 internal LGC email string, Joon Ho Lee (LGC Korea) emailed Jae Min
10 Park (LGC Korea), Jae Kil Kim, Hee Kwan Ra, Byung Ung Jang, and Jung Won Lee, sharing and
11 circulating "market information" that was "acquired from the Korean S Company" meaning
12 Defendant SDI. The email includes the instruction to "please share the followings with overseas
13 branch offices and local members as well as with other related departments within the Division if
14 necessary." The information contains SDI's plans for a price increase in June 2008 (and the amount)
15 and confirmation that SDI also talked to Sony regarding this "price adjustment" and "discussed on
16 sharing what is identified about Sony's movement and leading, and secured agreement intention."
17 The email also reports that there was a "dinner proposal" with the division leader around June [2008]
18 (Senior LG Chem Vice President JG Lee), "and exchanged opinions on strengthening working-level
19 employees' cooperation." On May 17, 2008, Joon Ho Lee sent the market information in summary
20 form (and enclosing the full report from May 16, 2008) to Sung Hwan Kim, Hee Kwan Ra, Byung
21 Ung Jang, Jung Won Lee, and Yoo Sung Oh (at LGCAI).

22 188. In a July 1, 2008 email from Sung Hwan Kim (LG Taiwan) to LGCAI's Joon Ho Lee
23 and Jae Min Park re "(HP/Dell pack) (Policy Sharing) (Taiwan Office) Report on competitors' price
24 increase," SH Kim reported on SDI Cheonan (packer) price to Dell and other pack increase price
25 information. In an earlier email, SH Kim reported to "share today's meeting minutes regarding 3Q
26 sales price and our policies." Participants in the meeting included: "Business Leader, Notebook
27 CRM, Taiwan and U.S. Offices." SH Kim reported on the future price increase plans of competitors
28 Sanyo, Sony, MBI, and SDI, and LG's policy in response, including the plan to "double-check the

1 price increase level of competitors, and apply price increase to our shipment from mid-July at the
2 latest.” SH Kim continued that “please make sure that sojourning employees share information on
3 competitors, re cell/pack price increases, by June 26.” In conclusion, SH Kim wrote, “please
4 frequently share information between the head office and overseas offices.”

5 189. In a September 3, 2008 email chain, Jae Kil Kim, Sr. Mgr. Battery Notebook CRM
6 Team at LGC Korea, emailed Jae Min Park (Senior Manager, LGCAI NY HQ (Houston) re “market
7 information” and shared information regarding a meeting with a company believed to be SDI. Kim
8 wrote that “In particular, in the 3Q price adjustment, it raised prices a lot more than the cost increase,
9 so it seems to think that it would be difficult not to relent to price adjustment for raw materials’ price
10 drop. . . . Price adjustment for D Company [SDI] is scheduled in Nov, so . . . no discussion yet. At
11 the moment, it is . . . focused on figuring out the industry’s trend, ***told us to basically move together,***
12 ***and has decided to delay a price cut and minimize a decrease level as much as possible.***” In a
13 September 5, 2008 email from Jae Min Park to Jae Kil Kim; Jung Han Park (LGCAI); Yoo Sung Oh
14 (LGCAI), Park wrote: “Let’s make it a principle that the US Office first checks the HQ’s opinions
15 after the Korean T-day holiday and officially responds [to HP]. If Ed [HP] requests a meeting . . .
16 let’s respond based on the officially prepared contents. Before that, let’s respond passively, saying
17 that currently in discussion with HQ.”

18 190. In a September 11, 2008 internal email, Jung Han Park (Manager, LGCAI , New York
19 office) wrote regarding “market information,” and reported on pressure from an LGC customer for a
20 price cut, and stated that “LGC too will have to discuss changing market dynamics with [SDI] and
21 others, and prepare our official position.”

22 191. On May 29, 2009, LGCAI’s JM Park stated in an email to LGC (executives Park, Jae
23 Min; Kim, Jae Kil; Kim, Hyun Soo; Jeong, Su Beom; Choi, Jeh Won; Lee, Hoon Ho) regarding
24 customer HP battery pack RFQ. LGCAI’s JM Park wrote that LGCAI sent its quote to HP at 2pm
25 ***“after checking that Cheon An Company completed price submission around 1:40 PM.”*** On
26 information and belief, Cheon An Company is a reference to Samsung and refers to a Korean
27 location where SDI has a plant. JM Park further wrote that Samsung offered 2.2Ah (\$20.5/pack),
28 2.8Ah (\$28.5/pack).

1 192. In December 2010, John Oh (Head of SDIA) communicated with employees of
 2 LGCAI regarding pricing plans for Apple. John Oh “promised to commit” to LG Chem’s proposed
 3 plan to raise prices to Apple by 10%. In an LG Chem email about LG Chem’s conversations with
 4 John Oh regarding pricing to Apple, YW Chung (of LG Chem Korea) reiterated to LGCAI employee
 5 Donny Lee (who had been in contact with John Oh), to “reassure [SDI’s John Oh] . . . and *when you*
 6 *have conversations with them [SDI], never leave any written evidence.*” In another email string
 7 between Donny Lee [LGCAI] and others at LG Chem in Korea, Lee reports on a meeting with John
 8 Oh regarding the Apple K93 contract. In the email, Lee confirms discussion with John Oh about the
 9 need to increase pricing to Apple. Lee notes that he told Oh about LG Chem’s plans to go ahead with
 10 at least the price of \$.50, and confirms that “SDI[A] VP Oh Yo Ahn agreed to this.”

11 193. On December 1, 2010, Donny Lee (LG Chem America) and Andrew Chung (LG
 12 Chem) communicated about ongoing discussions with SDI over a need to increase price regarding
 13 Apple’s K93 contract. Donny Lee used his contact and imparted wrong information about pricing
 14 and Andrew Chung argues that Mr. Lee must go back to his SDI contact and clear it up. Donny Lee
 15 was to follow up with SDI and to see if “they can move in same price range” as LG Chem needed to
 16 increase price. Mr. Chung wrote to Donny Lee that “We plan to go ahead with at least the price of
 17 \$.50. SDI VP Oh Yo Ahn agreed on this. Please try to reach a consensus on that with your
 18 counterpart.”

19 **B. LGCAI Employed Foreign Executives Who Participated in Conspiratorial**
 20 **Conduct**

21 194. LGCAI employed foreign executives who directly participated in conspiratorial
 22 conduct while working at LG Chem. Those executives’ conspiratorial conduct is detailed elsewhere
 23 herein. The following chart provides a summary:

Employee Name	IPP-First Amended CAC	Examples of Employee’s Roles with LGCAI
Yoo Sung Oh	IPP-CAC, ¹⁰ ¶¶ 64, 65, 66, 153,	Prior to 2004, Yoo Sung Oh (aka Brian Oh) was the Manager of Product and Planning, Battery Division for LG Chem in Korea, and attended and participated in collusive communications with

27 ¹⁰ For ease of comparison, citations noted with “IPP-CAC” are to the First Consolidated
 28 Amended Class Action Complaint, ECF No. 256, July 26, 2013. The same materials are also cited in the present Complaint.

Employee Name	IPP-First Amended CAC	Examples of Employee's Roles with LGCAI
		<p>competitors in that position.</p> <p>On or about October 2004, Mr. Oh was transferred to LG Chem's American Branch Office [LGCAI] to serve as part of LG Chem's Overseas Battery Department for the U.S. Mr. Oh held that position until at least 2007, if not longer. He was located in Austin, Texas and was believed to be in charge of the Dell account for LGCAI.</p> <p>While at LGCAI, Mr. Oh continued participating in collusive communications with competitors. For example, on October 25, 2005, employees from LGCAI, including Yoo Sung Oh (LGCAI, Austin, TX) and Young Sun Kim (LGCAI, San Jose, CA), discussed collaborating with Samsung SDI in negotiating prices to packer Simplo, and noted that they should watch SDI's offer prices when negotiating with Simplo.</p>
Jae Min Park	IPP-CAC, ¶¶ 114, 115, 116, 118, 119, 120, 121, 122, 128, 137, 158, 159, 160	<p>Jae Min Park was at LG Chem Korea (Senior Manager, Battery Notebook CRM Team) prior to 2008).</p> <p>On or about 2008, Mr. Park was transferred to LGCAI.</p>
Jung Han Park aka Jason Park	IPP-CAC, ¶¶ 134, 135, 137, 144, 160	Jung Han Park (aka Jason Park) was resident at LGCAI from at least 2005-2008 in the position of Overseas Battery Department U.S.
Young Sun Kim)	IPP-CAC, ¶¶ 15, 153, 101, 152	Young Sun Kim was resident at LGCAI, Overseas Battery Department from at least 2003-2007.

C. LG Chem Directed LGCAI's Pricing and Supply Decisions

195. LG Chem directed LGCAI's pricing and supply decisions. For example, On March 27, 2007, Jae Min Park (LGC Korea Senior Manager of Battery Notebook Team) participated in collusive communications with competitors (as detailed in first IPP-CAC) throughout the alleged class period. Park directed pricing to customers such as Dell and HP by instructing employees at LGCAI. For example, Jae Min Park emailed Yoo Sung Oh (Dell Account Manager at LGCAI in Austin, TX), and told him that with respect to concerns about packers lowering prices to HP and Dell, "[t]oday, [we] discussed with SDI [and] decide to maintain the 2Q pack price for Dell."

1 196. On October 11, 2007, Yoo Sung Oh of (LGCAI, Austin, TX) requested from LG
2 Chem a price to be offered to Simplo (a Taiwanese Packer), for packs to then be supplied to Dell.

3 197. On May 1, 2008, in an internal email from Jung Han Park (aka Jason Park) (LGCAI,
4 Overseas Battery Department), Park informed Joon Ho Lee (LGC Korea) about a likely price
5 increase by SDI. Park stated that “if SDI carries out a price increase, it is likely that other makers,
6 including LGC will join SDI’s price increase.” Joon Ho Lee responded to Park with redlines to his
7 original email, providing information on LGC’s own position on the price increase, explaining that
8 the price increase needs to be defended.

10 **2. SDIA’s Participation in the Conspiracy**

11 **A. SDIA’s Direct Communications Regarding the Conspiracy**

12 198. SDIA directly participated in collusive communications on numerous occasions. For
13 example, in December 2010, SDIA’s President John Oh communicated with employees of
14 competitor LG Chem’s US subsidiary, LGCAI, regarding pricing plans for Apple. John Oh
15 “promised to commit” to competitor LG Chem’s proposed plan to raise prices to Apple by 10%. In
16 an LG Chem email about LG Chem’s conversations with John Oh regarding pricing to Apple, YW
17 Chung (of LG Chem Korea) reiterated to LGCAI employee Donny Lee (who had been in contact
18 with John Oh), to “reassure [SDIA’s John Oh] . . . and when you have conversations with them
19 [SDIA], *never leave any written evidence.*” In another email string between Donny Lee [LGCAI]
20 and others at LG Chem in Korea, Lee reports on a meeting with SDIA’s John Oh regarding the
21 Apple K93 contract. In the email, Lee confirms discussion with John Oh about the need to increase
22 pricing to Apple. Lee notes that he told Oh about LG Chem’s plans to go ahead with at least the price
23 of \$.50, and confirms that “SDI[A] VP Oh Yo Ahn agreed to this.”

24 **B. SDIA Employed Foreign Executives Who Participated in Conspiratorial 25 Conduct**

26 199. SDIA employed foreign executives who directly participated in conspiratorial conduct
27 while working at Samsung. Those executives’ conspiratorial conduct is detailed elsewhere herein.

28 The following chart provides a summary:

Employee Name	IPP-First Amended CAC	Examples of Employee's Roles with SDIA
John Oh	IPP-CAC, ¶¶ 9, 57, 58, 60, 68, 69.	<p>From at least 2002-2006, John Oh (aka Yo-Ahn Oh), was General Manager at SDI Headquarters in Korea. During that time he participated in collusive communications with competitors.</p> <p>In 2006-2010, he was President of SDIA, or held a similar title as acting head of SDIA, in Irvine, California</p> <p>In 2009, he was VP, Head of North America Overall, location unclear)</p> <p>On or about 2006, John Oh was dispatched to SDIA in Irvine, California to be its acting President and direct all of its activities. John Oh is believed to have held that position until at least 2010 (or to have been at SDIA in some capacity until at least 2010).</p> <p>After Mr. Oh transferred to SDIA on or about 2006, his collusive communications with SDI's competitors continued.</p> <p>For example, in December 2010, John Oh was communicating with employees of competitor LG Chem's US subsidiary [LGCAI] regarding pricing plans for Apple. John Oh "promised to commit" to LG Chem's proposed plan to raise prices to Apple by 10%.</p> <p>In an LG Chem email about LG Chem's conversations with John Oh regarding pricing to Apple, YW Chung (of LG Chem Korea) reiterated to LGCAI employee Donny Lee (who had been in contact with John Oh), to "reassure [SDI's John Oh] ... and when you have conversations with them [SDI], never leave any written evidence."</p>
John Oh	IPP-CAC, ¶¶ 9, 57, 58, 60, 68, 69.	<p>In another email string between Donny Lee [LGCAI] and others at LG Chem in Korea, Lee reports on a meeting with John Oh regarding the Apple K93 contract. In the email, Lee confirms discussion with John Oh about the need to increase pricing to Apple. Lee notes that he told Oh about LG Chem's plans to go ahead with at least the price of \$.50, and confirms that "SDI[A] VP Oh Yo Ahn agreed to this."</p>

Employee Name	IPP-First Amended CAC	Examples of Employee's Roles with SDIA
Duck Yun Kim a/k/a DY Kim		<p>Duck Yun Kim (SDI Korea) participated in collusive meetings with competitors. For example, on 9/13/2007, he participated in a collusive meeting between SDI Korea and competitor Sanyo Japan (including Sanyo's President Sano) at the Pilgyunjae restaurant in Seoul, Korea.</p> <p>Info on meeting: Sanyo President Sano Meeting 9/13/2007</p> <p>Pilgyunjae restaurant in Seoul, Korea</p> <p>Attendees: President Sano, Tobata, Tabata, Sunaga, Eung Joon Ahn (Sanyo); president, Byugn Bok Jeon, DY Kim/DH Lee/In Sang Jeon (SDI)</p> <ul style="list-style-type: none"> - Collaboration on semiconductor - ongoing investments, - Discussion on PDP and AMOLED, TV business - batteries - discussion on Sanyo's slow battery business, "did not respond to the price reduction request although M/S for Nokia is up to 90%"; "upon request to a price reduction when the M/S dropped to 70% in 2004, [we] actually increased a price by a small amount with the reason of cobalt cost increase." - Cooperation - will set up windows so that the contents discussed between the two top managements could be carried out immediately. <p>By at least 2010, DY Kim had moved to SDIA as part of its batteries division.</p>

C. SDI Directed SDIA's Pricing and Supply Decisions

200. SDI directed SDIA's pricing and supply decisions. The SDI Batteries Department (SDI and SDIA) all fall under the same leadership and direction out of SDI Korea. SDI's organizational charts demonstrate that the batteries sales team spans all regions, and includes customers in all regions, including the U.S., and that all regions report back to the Sales Team Vice President (e.g. Jin Gun Lee).

201. An SDI memorandum dated December 17, 2008 was titled "Plan for Countermeasure for 2009 Apple e-bidding." SDI attendees for e-bidding events were listed as being from both SDIA and SDI Korean HQ – for SDIA, Director, John Oh, and from SDI Korea, Joon Yeol Yoon, a/k/a JY

1 Youn, Jong Sun Park, and Derrick Choi. The document details that part of the strategy for tendering
2 bids to Apple is the “suggestion of reasonable price through securing competitors’ price
3 information.”

4 **3. Sanyo North America’s Participation in the Conspiracy**

5 **a. Sanyo North America’s Direct Communications Regarding the**
6 **Conspiracy**

7 202. Sanyo North America directly participated in collusive communications on numerous
8 occasions. For example, on October 26, 2006, Takanao Matsumoto (SEC/Sanyo America) emailed
9 Katsuo Seki (of competitor NEC Tokin), and stated that he was currently in Japan and wanted to
10 exchange information about a customer, Motorola, before he returned to Chicago. Matsumoto
11 planned to wait for Seki at the Suidobashi subway station for the collusive communication.

12 203. On January 16, 2007, Katsuo Seki (of competitor NEC Tokin) emailed Takanao
13 Matsumoto (SEC/Sanyo America) to thank Matsumoto for contacting him and to plan for their next
14 meeting. Katsuo Seki stated that he would like to have dinner with Matsumoto and that Oka
15 (competitor NEC Tokin’s Director of Battery) wants to introduce himself to President Masato Ito of
16 SEC. On January 16, 2007, Matsumoto wrote back to confirm a meeting with Seki at around 6 p.m.
17 on January 26 “at the usual Suidobashi station” and that he would let President Ito know about Seki’s
18 request.

19 204. On January 25, 2007, Seki (of competitor NEC Tokin) emailed to apologize for
20 cancelling the meeting with Takanao Matsumoto (SEC/Sanyo America). On the same day,
21 Matsumoto replied and stated that President Masato Ito (SEC) welcomes the meeting that Katsuo
22 Seki requested earlier, but that “*it is not a good idea to meet at Awaji Plant, so a dinner [or lunch]*
23 *meeting in some other place such as Tokushima, Osaka or Tokyo is preferable.*” Matsumoto wrote
24 that Ito’s secretary will contact Seki’s secretary to set up the meeting.

25 205. Also on January 25, 2007, Takanao Matsumoto (SEC/Sanyo America) wrote to
26 President Masato Ito (SEC), reporting that Matsumoto has been in communication with Katsuo Seki
27 (of competitor NEC Tokin) “to exchange info re: Motorola.” He further wrote that “although
28 irregularly, [Matsumoto] has been exchanging information re: Motorola with Advisor [or Consultant]

1 Katsuo Seki of NEC Tokin [Seki recently retired from the managing director position, but still holds
2 a position as advisor/consultant] and that Seki contacted Matsumoto to set up a meeting between Oka
3 (NEC Tokin’s Director of Battery) and Ito. Ito replied on the same day, stating that “he remembers
4 meeting Seki in Osaka before” and that he “has no problem meeting someone in charge of battery
5 from NEC Tokin but does not think meeting at Sumoto plant is a good idea so wants to make it a
6 dinner [or lunch] meeting in Osaka or Tokushima.” President Ito also wanted Sanyo’s Katsushiro
7 Goto, Division General Manager of Lithium-Ion Battery, to attend.

8 206. On March 19, 2007, SEC/Sanyo America’s Takanao Matsumoto, stationed in
9 Chicago, Illinois, communicated with NEC Tokin’s Katsuo Tokin via email. Seki’s subject header
10 was “It’s Been a While.” Matsumoto wrote that “With the high materials fees, management is
11 becoming more intense . . . *I would like to exchange information.* If you have a chance to come to
12 Chicago, please contact me.”

13 207. On March 20, 2007, Takanao Matsumoto (SEC/Sanyo America) obtained pricing
14 information from competitor NEC Tokin and reported it to Sanyo Japan, including Terashima,
15 Gotou, Nishimura, Ueda, Tsukamoto, Sawada, Iguchi, Murata (SEC/Sanyo America), and Kobayashi
16 (SEC/Sanyo America). Matsumoto stated that he tried to get the person from NEC Tokin to talk on
17 the phone, but it was difficult without the help of alcohol. Matsumoto then listed the information he
18 obtained from NEC Tokin, including shipment volume, production issues, and NEC Tokin’s request
19 for a price increase. *Matsumoto instructed the email recipients to discard the email immediately*
20 *after reading.*

21 208. On March 24, 2007, Takanao Matsumoto (SEC/Sanyo America) wrote an internal
22 email stating that he “*has been getting really drunk with NEC Tokin [Katsuo Seki] and exchanging*
23 *information for a while.*” He also wrote that Sanyo’s Iguchi “has been secretly contacting
24 [competitor] Hitachi Maxell” and that information is expected soon.

25 209. On June 12, 2007, Takanao Matsumoto (SEC Sanyo (USA)) and Katsuo Seki (of
26 competitor NEC Tokin Japan) communicated by email. Matsumoto asked whether Seki would be
27 attending the QBR in Atlanta, and stated that order quantities were decreasing rapidly due to the
28 cellular phone device sales slump. Matsumoto further stated that he tried to increase prices with

1 Motorola but did not receive a good comment. He asked to talk on the phone on June 13th to
 2 exchange information. Seki stated that the 14th would work, and Matsumoto stated that he would
 3 call by 11 Japan time on the 14th.

4 **b. Sanyo North America Employed Foreign Executives Who Participated in**
 5 **Conspiratorial Conduct**

6 210. Sanyo North America employed foreign executives who directly participated in
 7 conspiratorial conduct while working at Sanyo. Those executives’ conspiratorial conduct is detailed
 8 elsewhere herein. The following chart provides a summary:

Employee	IPP-First Amended CAC	Examples of Employee’s Roles with Sanvo North America
Mr. Ikegami	IPP-CAC, ¶¶ 120, 121, 125, 141, 160	<p>Mr. Ikegami (General Manager for Sanyo Japan from 2005 to at least 2008, if not longer), spent 8 years in the United States at Sanyo’s U.S. subsidiary, SEC Sanyo, as a “sojourning” employee of Sanyo Japan from 1997-2005.</p> <p>From 1997-2002, Mr. Ikegami, was at Sanyo USA in Chicago, with responsibility for the Motorola and Black & Decker Accounts.</p> <p>Then, from 2002-2005, he was located in Austin, TX (presumably to work on the Dell and/or HP accounts).</p> <p>Upon his return to Sanyo Japan headquarters, Mr. Ikegami was a frequent participant at collusive competitor meetings.</p> <p>For example, on 1/28/2008, Mr. Ikegami (on behalf of Sanyo Japan) met with LG Chem executives at Narita Airport in Tokyo. They discussed “future exchanges of market information, customer demand, capacity, pricing, and agreeing that information bearing on prices and production costs should “not be opened to customers.”</p> <p>The group also discussed the need to conceal the meeting, and in an LG Chem report on the meeting, recipients were instructed to “delete it upon reading.”</p> <p>On March 2, 2008, Mr. Ikegami met with high level executives from LG Chem, again, at the Akasaka restaurant and discussed pricing to US customers such as Dell, Acer, Lenovo, and others). <i>See also</i> IPP-CAC, ¶¶ 139, 141 (detailing additional collusive meetings with Ikegami and LGC).</p>
Takanao		In 2006 and 2007. sojourning executive. Takanao

Employee	IPP-First Amended CAC	Examples of Employee's Roles with Sanvo North America
Matsumoto		<p>Matsumoto (Vice President for Sanyo Energy USA), traveled back and forth between Japan and the U.S.</p> <p>During this time period, he personally participated in collusive meetings in Asia and set up collusive meetings for foreign defendant, Sanyo Japan.</p> <p>During this time period in the U.S., Matsumoto received pricing direction from foreign defendant, Sanyo Electric (Japan), continued his collusive communications with competitors in Asia and was involved in pricing for Lithium Ion Batteries to be sold in the U.S. to U.S. customers.</p>

c. Sanyo Japan Directed Sanyo North America Pricing and Supply Decisions

211. Sanyo Japan directed Sanyo North America's pricing and supply decisions. For example, on December 25, 2006, Sanyo Japan gave Sanyo USA price direction, showing parent company pricing authority. Tsukamoto (from SM Energy in Japan) emailed VP Matsumoto (SEC USA) and listed his responses to a (customer) Motorola email regarding price. Tsukamoto listed Sanyo Japan's bottom price and asks Matsumoto to negotiate for a 80% market share.

212. On June 16, 2008, Sanyo Japan (Mr. Tsukamoto and SEC (USA) Mr. Matsumoto) communicated regarding the "CY08/3Q Prismatic Li-Ion price for Motorola." Tsukamoto suggested Matsumoto to have Motorola commit the volume with the cheaper price than Sanyo previously offered for CYQ3, and Matsumoto asked for more discount prices with Motorola's request.

213. On April 14, 2009, Sanyo USA (Han Phan) emailed Japan (Tetsu Tenjikukatsura) asking for "Japan's quote" for a customer who needs a battery to make a portable chainsaw.

214. On July 27, 2010, Kazuhiko Nakamura (Sanyo Japan) gave negotiating instructions pertaining to cost to Tanigawa (SEC Sanyo/M) by conveying costs necessary for discussion with the other side. SEC's Tanigawa requests an internal consensus with the cost details provided. Japan's Nakamura replied that he wanted Tanigawa to try harder and provided additional negotiation instructions.

1 **4. Panasonic North America’s Participation in the Conspiracy**

2 **a. Panasonic North America’s Direct Communications Regarding the**
3 **Conspiracy**

4 215. Panasonic North America directly participated in collusive communications on
5 numerous occasions. For example, on September 23, 2003, Thomas Kowalak (Senior Account
6 Manager at PIC in Austin, Texas) emailed Toshio Katsube and others at Panasonic Japan and
7 Panasonic US regarding “Confidential Meeting with Sanyo Account Manager.” Kowalak reported
8 that he met with competitor Sanyo’s Account Manager today [presumably Sanyo’s US account
9 manager in Texas] to “discuss the battery business at Dell.” Kowalak itemized the topics discussed,
10 including engineering issues and procurement issues. Regarding Dell’s request for a delay in
11 shipment, Kowalak reported that “Sanyo has refused to comply as have we for the month of Sept.”

12 216. On July 19, 2006, Simon Chan of Panasonic Hong Kong gathered information from
13 competitor Sanyo Energy and sent the information to Takaro Yoshida (likely in Japan), who then
14 forwarded the email to Bob Rauh (in the US, PIC/PNA). Chan met directly with Sanyo about battery
15 business, and he emailed a report stating, “Yesterday and today we collected information about
16 Sanyo’s Power Ion as follows: 1) info from Sanyo energy directly July 19 AM.”

17 217. On December 8, 2008, Toshiyuki Katsube, Overseas Sales Part Leader for Panasonic
18 Corp. in Japan and Yasushi Matsumoto, General Manager for Panasonic Corp. in Japan, attended a
19 collusive meeting with high-level executives from LG Chem, Ltd. in Korea, including Vice President
20 Joon Ho Lee and Deuk Yong Kwon, in Osaka, Japan. At the meeting, the attendees discussed
21 customer demand, capacity and line extension plans, and selling prices. Regarding selling prices,
22 “Both companies agreed that they should defend the current selling price because it is hard to secure
23 volume through price cutting.”

24 218. Then, on December 10, 2008, both Messrs. Katsube and Matsumoto were involved in
25 directing Panasonic’s U.S. sales team on pricing to be offered to Apple. On an internal Panasonic
26 email string with executives from both Panasonic Corp. Japan and PENAC in the U.S., Tina Phan
27 (Global Sales Manager for PENAC), requested a price quote for Apple from executives at Panasonic
28

1 Corp. in Japan). Mr. Toshi Umemura of Panasonic Japan writes back with pricing to be offered to
2 Apple, cc'ing Mr. Katsube and Mr. Matsumoto.

3 219. On July 7, 2010, PNA received confidential pricing information from competitor
4 Sony. The email thread concerns B & D (Black & Decker) business. In a July 7, 2010 email from
5 Kenny Huang (Panasonic Taiwan) to other Panasonic employees, including Barbara Lahey
6 (PIC/Panasonic America), he stated: "I got information from Sony: 1. Sony's 26650 2.6Ah price is
7 \$5.00 ~ 5.30 to TWN pack maker. And Sony did not sell 26650 to STL/B&D project, only 18650
8 cells." Tsuyoshi Hattori (Corporate Industrial Marketing & Sales Div., Panasonic Corporation)
9 confirmed the battery size with Huang. Takahiro Yoshida wrote on July 9, 2010, that US subsidiary
10 PIC will be working with the customer: "The price negotiation and spec discussion is with B&D and
11 will be through PIC to B&D." He also wrote, "Referecing [sic] the competitors information as
12 below, I will work with the factory side for the best pricing." On July 13, 2010, Yoshida provided "a
13 target price to negotiate with BU side." Shuzo Yamada (Panasonic America) and Hiro Matsuno
14 (Panasonic America) were later cc'd on the email chain on July 8, 2010.

15 **A. Panasonic Japan Directed Panasonic North America Pricing and Supply Decisions**

16 220. Panasonic Japan directed Panasonic North America's pricing and supply decisions.
17 For example, Panasonic Japan issued prices to customer Apple Computer through the Panasonic US
18 account team. A December 10, 2008 internal Panasonic email string regarding pricing to Apple
19 included employees from Panasonic US (Panasonic Industrial Co, Global Sales Mgr Tina Phan,
20 David Martinez; Shauna Peterson, and others) and Panasonic Japan (Yasushi Matsumoto, Keisuke
21 Tanaka, Fukutome Kazutaka, Toshi Katsube, Haruhiko Hayashi and others). Conference calls were
22 planned for Japan/US conversation re Apple. In preparation for the call, Tina Phan told the group
23 that Joe Kelleher (Apple) requested a price quote for Apple by Wednesday, December 10, 2008 at the
24 latest, and Phan requested that Umemura (Pana Japan) provide the cell pricing for Apple. Umemura
25 then wrote back to Tina Phan/David Martinez with the price and volume availability to give to
26 Apple.

1 **5. Sony North America’s Participation in the Conspiracy**

2 **a. Sony North America’s Direct Communications Regarding the Conspiracy**

3 221. Sony North America directly participated in collusive communications on numerous
4 occasions. For example, an SEL (California) internal slide presentation dated September 26, 2006
5 contained sensitive, competitive information obtained from competitor LG Chem, including their
6 line status in 2006, their stance on investments, profits and productivity. The source of the
7 information appears to be LG Chem, based on a quote of LG’s anonymous executive’s comments,
8 “[we] cannot think of 50% share” and “as to pricing, we want to avoid such a drastic price reduction
9 as in the last year.” Another slide contains sensitive SDI information, including their entry to Neo in
10 October, 2006, and yield rates. This slide stated that “*per our information exchange with LG Chem,*
11 *SDI’s commitment to polymer is questionable.*”

12 **b. Sony North America Employed Foreign Executives Who Participated in**
13 **Conspiratorial Conduct**

14 222. Sony North America employed or otherwise utilized foreign executives who directly
15 participated in conspiratorial conduct while working at Sony. Those executives’ conspiratorial
16 conduct is detailed elsewhere herein. For example, Taku Katahira (General Manager of the Sales
17 Department for Sony Japan) was a participant in collusive meetings with other foreign defendants
18 during the alleged class period. Mr. Katahira was also involved in the day-to-day pricing activities of
19 Sony’s US subsidiary. For example, on July 17, 2007, Mr. Takahira was on an email string along
20 with Sony US employees regarding the Apple and Rim accounts. Robert McCaul of Sony US, asks
21 Mr. Keishi Hayasaka (Sony Japan) to approve the price for Apple (as proposed during his
22 negotiation with Apple that day). The email is also addressed to Mr. Katahira and others from Sony
23 Japan.

24 223. On August 11, 2004, high level executives from Sony Japan told high level executives
25 of LG Chem Korea of its plans to respond to U.S. customers by dispatching five employees to the
26 United States.

27 224. Sony Corp.’s Japanese employees also frequently travelled to the United States to
28 oversee its subsidiary’s Lithium-Ion Battery-related business in the United States. For example, on

1 May 2, 2008, Sony executive Kenji Enomoto (Sony Japan) emailed Kenichi Hoshino and Robert
2 McCaul, telling them that an employee from Sony Corporation (in Japan) would be moving to the
3 U.S. to help support Apple.”

4 **c. Sony Japan Directed Sony North America Pricing and Supply Decisions**

5 225. Sony Japan directed Sony North America’s pricing and supply decisions. For
6 example, on June 22, 2005, Steve Jaska, of Sony U.S. in Texas, indicated in writing to Takeshi
7 Nakayama of Sony Japan that he needed to get pricing for U.S. customer Dell Computer from Sony
8 Japan.

9 226. On February 12, 2008, Noriko Kazama from Japan (Core Components Business
10 Group, Sony Corp.) writes to subsidiary employees Rob McCaul (Senior Manager, CSBD, SONY
11 Electronics -San Jose, California) and Yuki Walsh (Senior Marketing Specialist of Sony Electronics
12 in San Diego, California) regarding a pricing proposal to Apple, and stated “I have discussed the
13 price reduction issue for Apple with our control division and concluded that we would reduce the
14 price to \$53.10 . . . we would like you to withdraw our pricing proposal that we reduce the price to
15 \$52.50 from \$53.23 in April . . . we have to ask you to negotiate with Apple again due to the high
16 cobalt prices.”

17 227. Similarly, on August 2, 2008, Keishi Hayasaka (an executive from Sony Corp. in
18 Japan) emailed Robert McCaul in San Jose, California telling him that the pricing for “Single cell
19 sample pricing” should be “\$4.00/cell.” Prior to that email, McCaul wrote to Hayasaka requesting
20 price confirmation regarding “Single cell sample pricing” on August 1, 2008.

21 228. On October 1, 2009, Robert McCaul of Sony U.S. in San Jose, California wrote in an
22 email that he would be at headquarters in Japan on a business trip and asked the Sony U.S. team for
23 updates on their Mobile/PC customers so he could get answers from Japan. Sony U.S. gave a status
24 update on the Motorola account and asked Sony Japan what prices Japan wanted to quote to
25 Motorola.

26 229. On January 7, 2010, Marcel van den Bogert (Strategic Account Manager of Sony’s
27 U.S. subsidiary) sent an email to Robert McCaul regarding a trip to Japan. Mr. van den Bogert stated
28 that Sony Corp. would “prepare proposal of what 18560’s Sony want to quote to Motorola and at

1 what pricing.” Earlier in the email chain, on September 29, 2009, Robert McCaul wrote that he
2 would be at Sony’s Japanese headquarters and asked his Sony America team: “Can you please send
3 me the latest update on each of your respective Mobile/PC customers as I will be having a series of
4 meeting with the Jigyoubu [operations] ... so please highlight areas where we need
5 answers/homework support from Japan to close pending issues.”

6 230. On May 9, 2010, Robert McCaul of Sony Electronics -San Jose, California wrote to
7 Koichi Fukata, Manager of Sony Energy Devices of Japan, regarding the customer RIM, that “[w]e
8 request that you consider a price competitive with Sanyo (Sanyo Price= below \$3.50).”

9 231. On October 28, 2010, in an email regarding “Dell’s Project Update,” Yosuke Kiyama
10 in the San Jose, California office wrote to Mike Wu in Taiwan and stated that “This price is officially
11 approved by Japan.”

12 **6. Maxell Corp. of America’s Participation in the Conspiracy**

13 **a. Maxell Corp. of America’s Direct Communications Regarding the**
14 **Conspiracy**

15 232. In March 2007, Matsumoto (Sanyo Energy (USA) Corporation) wrote to Mr. Noguchi
16 (Sanyo Mobile Energy in Japan), “I have been occasionally exchanging the information with NEC
17 Tokin for some time while drinking until we get drunk in Tokyo. The person at the other side is an
18 executive managing director. ... On the other hand, as for Hitachi Maxell, [Mitsuru Iguchi of Sanyo
19 GS Soft Energy Co., Ltd.] has been contacting underneath the surface. We expect to acquire the
20 information in a few days, so I will forward it to you again.”

21 233. On June 4, 2007, Matsumoto received an email from Iguchi (Sanyo GS Soft Energy
22 Co., Ltd.) in which Iguchi relayed information he acquired from “Maxell,” including its production
23 capacity, packing process, price negotiations with customers, shipping routes and future purchasing
24 plans, and shared it with Sanyo Electric Co. Ltd.

25 234. In January 2010, Hitachi Maxell, Ltd. met with Motorola, a customer of Hitachi
26 Maxell and several of its competitors. Following the meeting, Hitachi Maxell’s Hiroshi Miyaji
27 advised both Hitachi Maxell and Maxell Corporation of America employees that he will confirm the
28 information he received from Motorola with LG.

b. Hitachi Maxell, Ltd. Directed Maxell Corp. of America’s Pricing and Supply Decisions

235. Hitachi Maxell, Ltd. directed Maxell Corp. of America’s pricing and supply decisions. For example, on January 26, 2007, Akitaka Yamamoto (Manager of America & Europe Business Planning Department of Hitachi Maxell in Japan) reported via email that the subsidiary Maxell Corp. of America had been requested by Markiv, believed to be a customer, to lower its price offer. After pricing discussion among the Japanese parent company employees, Yamamoto of Japan sent the pricing decision to Tatsuya Shigeno and Stan Takao of Maxell Corporation of America stating “Below is the response.”

C. Economic Evidence Shows Defendants’ Conspiracy Succeeded

1. Defendants’ Conspiracy to Raise LIB Prices Broke Apart Soon After They Received DOJ Subpoenas

236. Defendants’ illegal behavior, alleged herein, artificially stabilized and raised the prices of Lithium Ion Batteries during the Class Period. Lithium Ion Battery prices were higher than they would have been absent the conspiracy. Figure 6 is an index which shows the average selling prices for Lithium Ion Batteries during the Class Period.

Figure 6: Bank of Korea Lithium Ion Battery Price Index

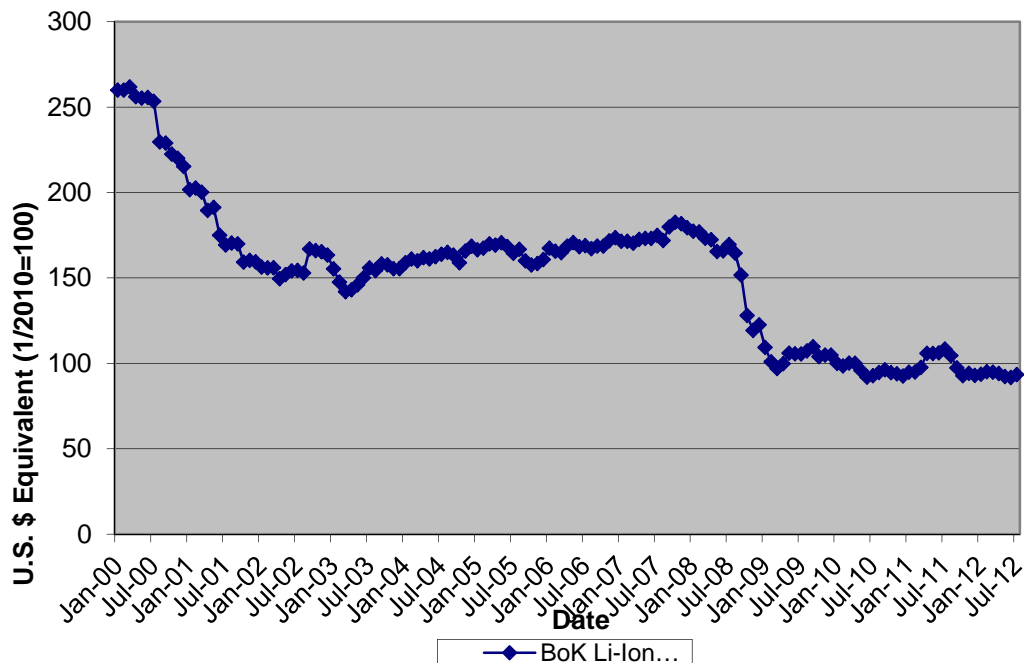

1 237. Coinciding with the worldwide economic crisis beginning in or around 2007, and the
2 market shock to the demand for Lithium Ion Batteries and electronic devices, the prices for Lithium
3 Ion Batteries declined. Beginning in or around January 2008, the prices for Lithium Ion Batteries
4 began to decline. This decline ended in or around January 2009; the price decline during this period
5 was approximately 40 percent.

6 238. During this period of declining prices during 2008, Defendants cut production in
7 response to change in demand and to help stem the decline in prices. Beginning around 2008,
8 Defendants cut worldwide production for Lithium Ion Batteries by almost 66 percent. This dramatic
9 cut in production achieved its desired result – the prices for Lithium Ion Batteries stabilized by the
10 end of 2009.

11 239. Lithium Ion Battery prices remained stable until Defendants received notice in mid-
12 2011 that they were being investigated for price-fixing Lithium Ion Batteries by the DOJ and the
13 European Union. Both the Japanese and Korean producer price indexes for Lithium Ion Batteries fell
14 after Defendants disclosed they were being investigated. In fact, within three (3) months following
15 disclosure of the investigation in 2011, prices began an approximate 10 percent decline in a mere
16 three (3) months. Such a price decline would be predicted with the end of a cartel which had
17 artificially raised prices, and further supports the conspiracy’s existence before this time.

18 240. On May 3, 2011, Sony received a subpoena from the DOJ for information on
19 competition in rechargeable batteries, and disclosed this information in late June. The chart below
20 shows the Bank of Japan’s export price index for Lithium Ion Batteries prior to this announcement
21 and prices following the announcement. Comparing the average from January 2010 to June 2011
22 with the average from July 2011 to January 2012, prices fell by nearly 7 percent between June and
23 July 2011. From July 2011 to January 2012, prices were 9 percent lower. Figure 7 shows the steep
24 drop in Lithium Ion Battery prices that occurred after the DOJ served subpoenas on Defendants.

Figure 7: Prices of Lithium Ion Batteries Surrounding Announcement of DOJ Investigation

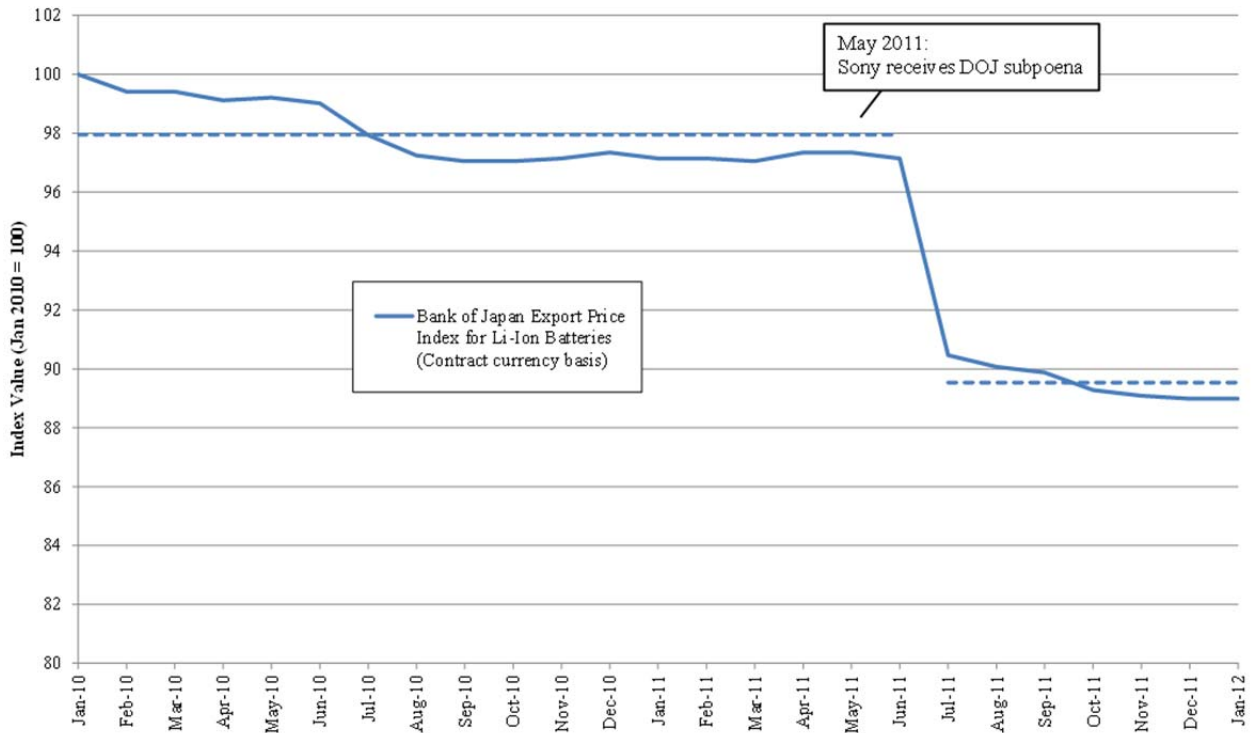

Source: Bank of Japan.

241. Using an additional Lithium Ion Battery price index maintained by the Bank of Korea which spans the Class Period, it is apparent that the drop in mid-2011 is indeed significant. Similar to the Bank of Japan index, the Korean price index also shows a one-month drop of more than 6 percent from August to September 2011 (the drop in the Japanese index occurs from June to July 2011). This 6 percent drop was part of three successive months of price drops that totaled almost 16 percent between July and October. The only other time during the Class Period where similar price declines can be observed is between August 2008 and February 2009, when the industry was experiencing a demand shock due to the effects of the global recession. Figure 8 therefore is a different price index (from the Bank of Korea) which shows Lithium Ion Battery prices from January 2002 to January 2012. Again, this economic data depicts a large and unusual historical price reduction following close in time to the DOJ's investigation.

Figure 8: Bank of Korea Lithium Ion Battery Price Index and Large Three-Month Price Declines

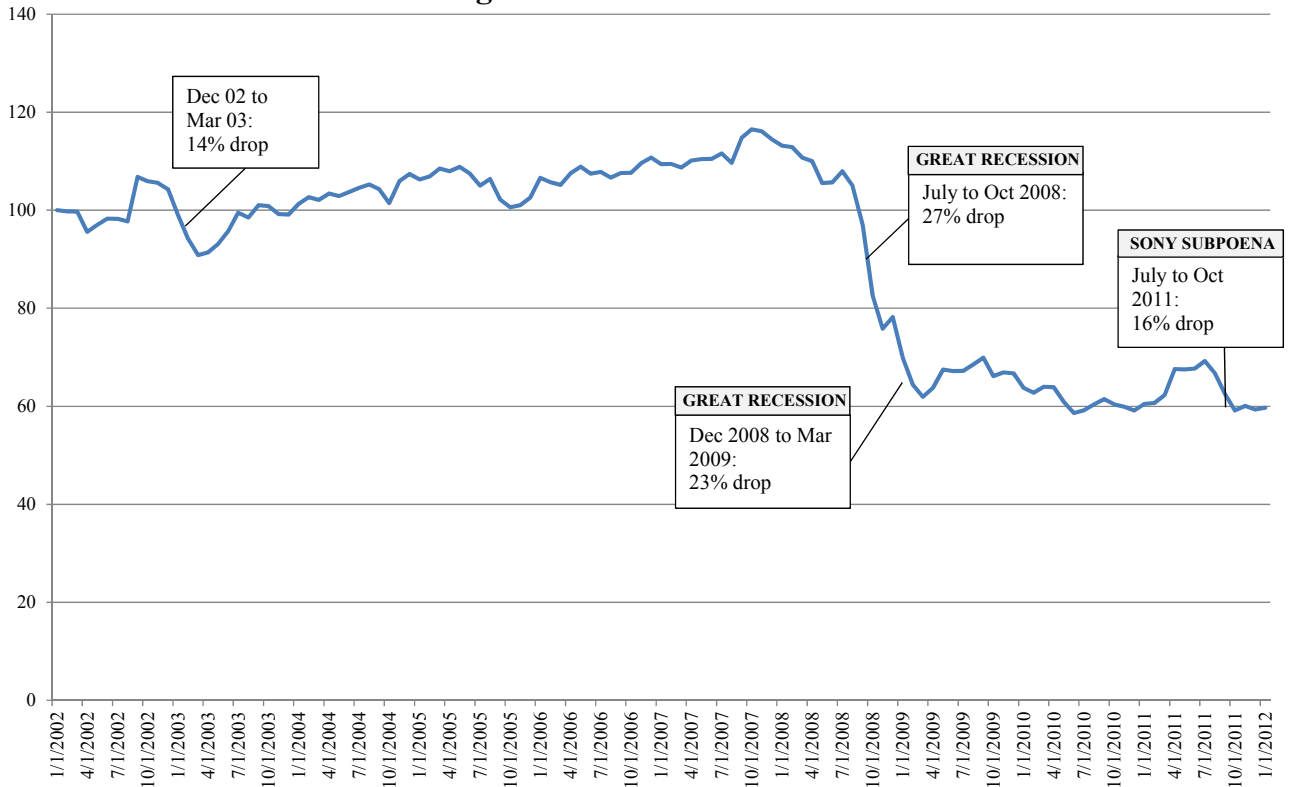

Source: Bank of Korea (converted to USD using exchange rates in Bloomberg).

2. Prices for Lithium Ion Batteries During the Class Period Defied Industry Expectations

242. Many analysts predicted that given the economics of the marketplace, prices of Lithium Ion Batteries would go down during the Class Period. But prices not only failed to decline throughout most of the Class Period – prices actually rose, defying industry expectations.

243. Lithium Ion Batteries underwent continuous technological change that rapidly improved the energy density of the batteries (watt-hours delivered per weight or volume) and reduced costs. Energy density, measured in watt-hours per kilogram or watt-hours per liter, more than doubled for Lithium Ion Batteries over the decade from 1991 to 2001. Such technological progress continued unabated over the past decade – today, energy density is as high as 250 wh/kg, or

620 wh/l, for Lithium Ion Batteries.¹¹

Figure 9: Performance Improvement and Price Decline in Li-Ion Batteries, 1991-2002

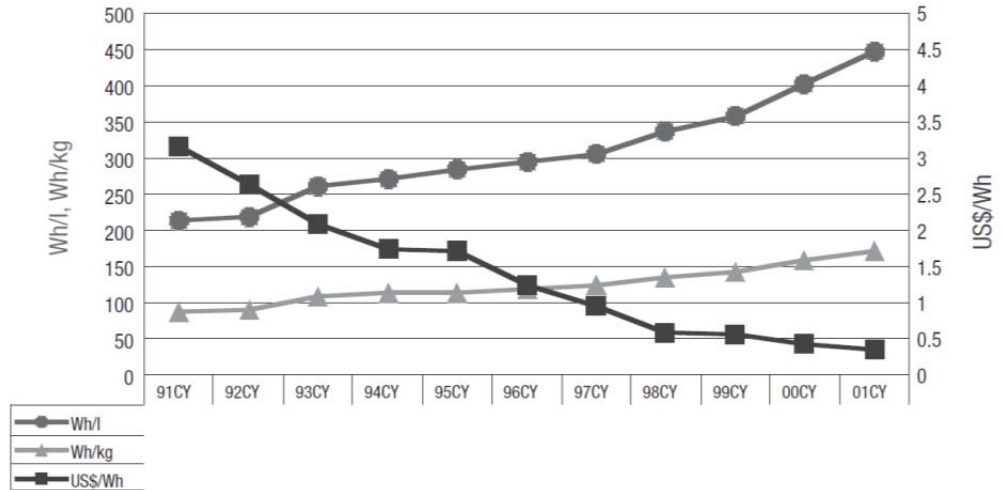

Source: Institute of Information Technology, Ltd. Japan. 2002.

Reproduced from R. Brodd, "Factors Affecting U.S. Production Decisions: Why are There No Volume Lithium-Ion Battery Manufacturers in the United States?" ATP Working Paper 05-01, National Institute of Standards and Technology, U.S. Department of Commerce, June 2005, p. 62.

244. Scientists, engineers, and industry analysts expected to see the declining prices for Lithium Ion Batteries shown in Figure 9 to continue their steep descent during the period following 2002. Numerous technical studies undertaken in the early to mid-2000s predicted that scale economies and learning curves would act to sharply lower cost as production volumes expanded. Figure 10 below is typical of such predictions.

¹¹ Panasonic Develops New Higher-Capacity 18650 Li-Ion Cells; Application of Silicon-based Alloy in Anode, Green Car Congress (Dec. 25, 2009), <http://www.greencarcongress.com/2009/12/panasonic-20091225.html>.

Figure 10: Reduction in Li-ion Battery Manufacturing Cost with Scale of Production

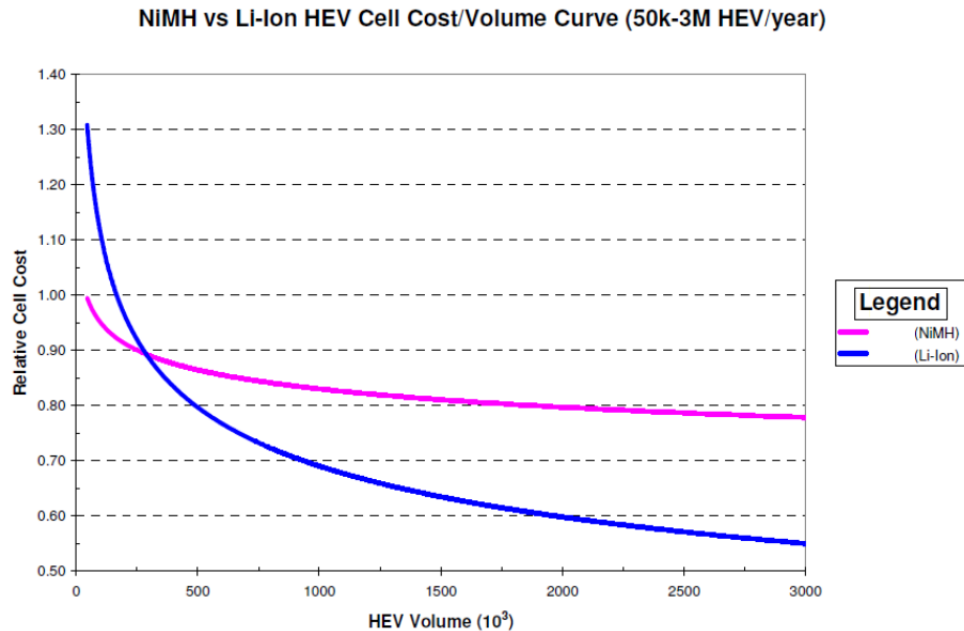

Source: Internal Studies at Ford, taken from presentation by T. Miller, “Hybrid Battery Technology and Challenges,” MIT Technology Review’s Emerging Technology Conference, (September 28, 2006), reproduced in M.A. Kromer and J.B. Heywood, “Electric Powertrains: Opportunities and Challenges in the U.S. Light-Duty Vehicle Fleet,” Publication LFEE 2007-03 RP, Laboratory for Energy and the Environment, MIT, May 2007, p. 36 (hereafter “Kromer and Heywood”).

245. The study cited in Figure 10 also notes the rapid pace of continuing technological improvement: “while the NiMH [nickel metal hydride] battery is nearing fundamental practical limits . . . lithium ion batteries are still improving. With continued improvements in charge storage capability, lithium-ion’s advantage will become more pronounced with the passage of time. . . . Though this trend has slowed somewhat in recent years with the maturation of cobalt- and nickel metal-oxide based lithium-ion batteries, other materials have the potential to allow for continued growth”¹²

246. The authors of this 2006 study go on to observe that:

In addition to this fundamental advantage with respect to specific energy and power, lithium-ion batteries also offer the potential for lower cost as the technology matures and production volumes increase. Although more expensive than NiMH batteries today, lithium-ion batteries scale more readily to high volume production hence have greater potential for cost reduction. . . . Perhaps more importantly, while the most expensive constituent materials of NiMh battery are intrinsically tied to the commodity price of nickel (relatively

¹² M.A. Kromer and J.B. Heywood, *Electric Powertrains: Opportunities and Challenges in the U.S. Light-Duty Vehicle Fleet*, Publication LFEE 2007-03 RP, Laboratory for Energy and the Environment, MIT, May 2007, p. 36.

expensive), lithium ion batteries may be made from a number of different fungible materials. . . . Over the longer-term, there is strong potential to transition to even lower cost materials.”¹³

247. As seen in Figure 11 below, which represents production figures for Lithium Ion Batteries manufactured by Japanese manufacturers (responsible for the lion’s share of global production throughout this decade), the predicted expansion in the production volume of Lithium Ion Batteries did indeed materialize. Batteries produced in Japan more than tripled from just below 34 million units in January 2001, to almost 118 million units in July 2011. The power provided by these technologically improved batteries increased twice as fast, by a factor of almost six over the same period, from just over 34 million Ah (amp-hours), to over 200 million Ah in July 2011.

Figure 11: Increase in Production Volumes for Li-Ion Batteries in Japan 1000’s of Units and Ah

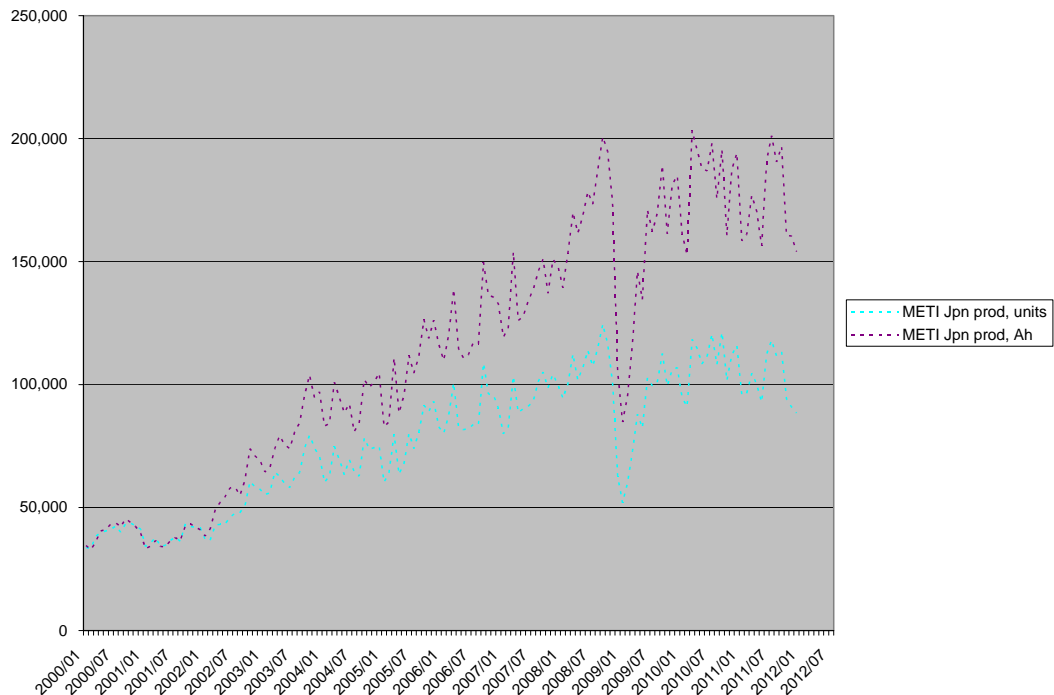

Source: Japan, Research and Statistics Department, Ministry of Economy, Trade and Industry (METI), *Yearbook of Machinery Statistics, Monthly Report of Machinery Statistics*, various years.

248. Thus, analysts were confident in predicting continuing price declines in Lithium Ion Batteries at the beginning of this decade. Basic economics supports the notion that these rapidly increasing volumes of production should have been associated with continuing price declines for

¹³ *Id.*

1 Lithium Ion Batteries in a competitive market. After price declines prior to 2002, and flat prices in
 2 2003, industry analysts continued to predict continued annual 7 percent declines in Lithium Ion
 3 Battery prices after 2003. However, these continuing price declines predicted by both technologists
 4 and market analysts did not materialize because of the formation of the price-fixing cartel alleged in
 5 this Complaint. The interruption of this trend in 2003 was viewed merely as a temporary deviation
 6 from the expected trend, rather than the beginning of a collusive effort by producers to prevent
 7 further declines in prices. Figure 12 shows analysts' predictions that prices would continue to decline
 8 as they had done in previous years – but they did not.

9 **Figure 12: Historical and Forecast Prices for Batteries, April 2004**

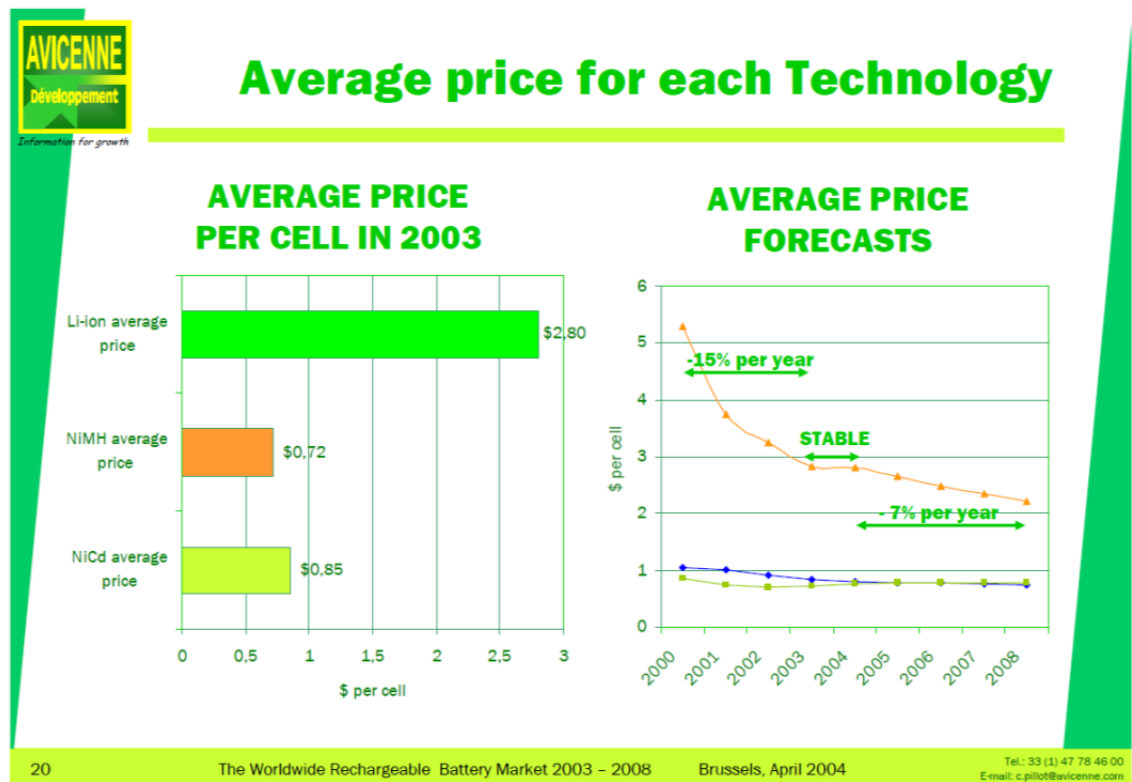

23 Source: International Association for Advanced Rechargeable Batteries,
 24 www.rechargebatteries.org/MarketDataRechargeableBatteries.pdf.

25 249. These trends in pricing that defied industry expectations are evident in the official
 26 government producer price index for Lithium Ion Batteries constructed by the Bank of Korea, Korea
 27 being the second most important location for Lithium Ion Batteries production (after Japan, which
 28 did not start producing a Lithium Ion Batteries price index until 2010). A price index, unlike an

1 average unit value for batteries, controls for changes in mix of size and qualities of batteries being
 2 produced.

3 **Figure 13: Lithium Ion Battery Price Indexes, 2000-2012**

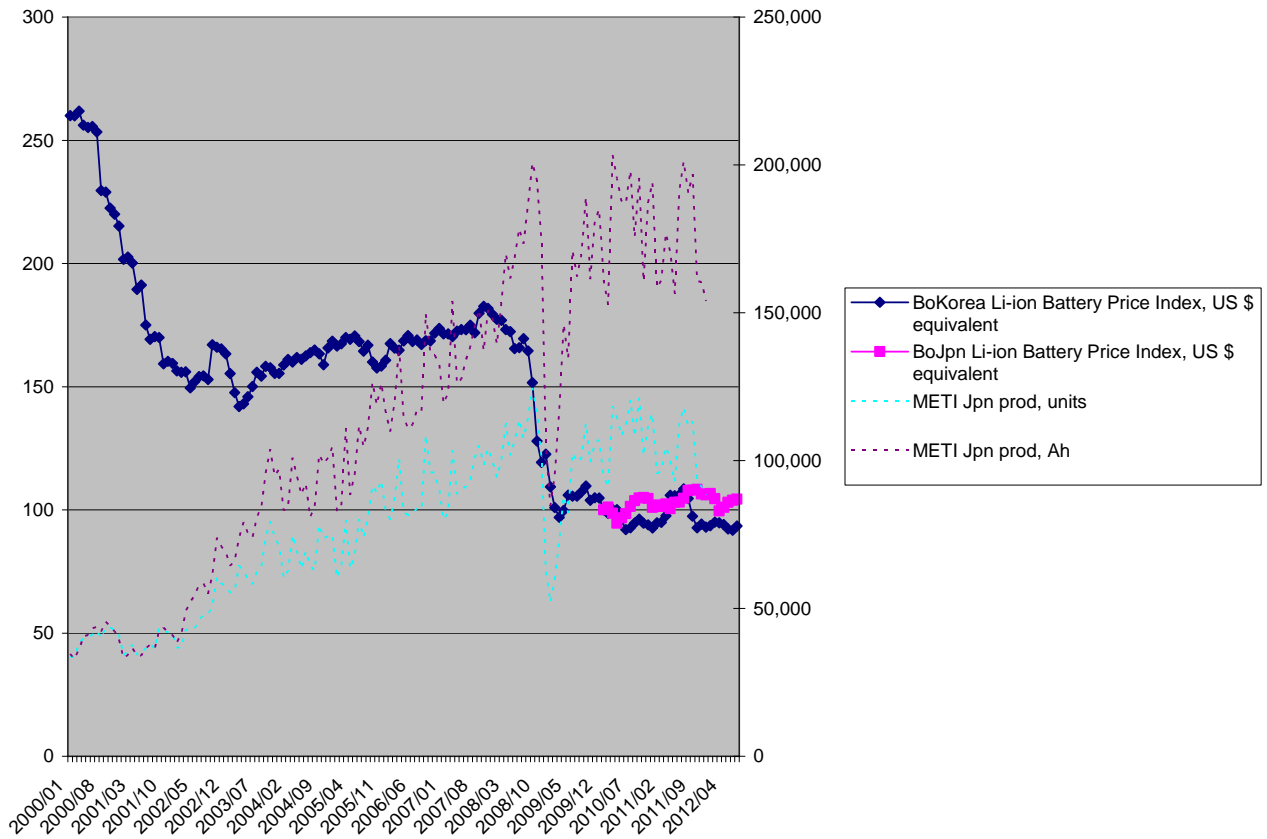

18 Source: Bank of Korea, Bank of Japan. Price indexes have been converted to dollar equivalents using Federal Reserve exchange rate data.

19 250. Figure 13 shows that after the decline in prices beginning in early 2000 (triggered by
 20 entry of Korean producers into the market), the cartel members managed to arrest any continuing
 21 decline in Lithium Ion Battery prices, and, defying industry expectations, even increased prices, over
 22 a five year period, from early 2002 through early 2008. This effort was highly successful in not only
 23 reducing the rate of decline, but actually elevating Lithium Ion Battery prices until the Great
 24 Recession struck in 2008. At that point, as markets for the mobile consumer electronics and
 25 information technology products reliant on the use of Lithium Ion Batteries were impacted by the
 26 recession, prices started to reduce once again, at an even steeper rate than had been triggered by
 27 Korean entry back in early 2000.

1 **3. The Defendants' Pricing and Production Levels in Response to the Global**
2 **Economic Crisis in 2008 Further Supports the Existence of the Conspiracy**

3 251. As the global recession reduced demand for the devices which use Lithium Ion
4 Batteries, prices for these batteries also dropped. In fact, prices for Lithium Ion Batteries would fall
5 roughly 34 percent from August 2008 through January 2009. Faced with rapidly decreasing prices
6 during this time, cartel members sharply cut back production of Lithium Ion Batteries. Japanese
7 cartel members dramatically cut production from 125 million units a month in September of 2008, to
8 52 million units per month in January of 2009, engineering a reduction in output of 58 percent over a
9 period of just four months. (Alternatively, if measured by the power capacity – Ah – of the batteries,
10 the same 58 percent reduction occurred). Then, just five months later, Japanese production shot back
11 up near pre-economic crisis levels to approximately 103 million units per month.

12 252. Defendants' near 60 percent reduction in output successfully arrested further decline
13 in prices, while the continuing restraint in not resuming production growth after 2008 successfully
14 stabilized prices at a roughly constant level, and stemmed further price declines.

15 253. Economic principles teach that when producers are behaving competitively, they
16 expand output to where price just covers the incremental or marginal cost of the last unit produced.
17 Defendants' reduction in production by 58 percent – only to increase output five months later to
18 nearly the same production levels (while holding prices the same) – is not plausibly explained by
19 competitive forces.

20 254. This production and pricing behavior is better (more plausibly) explained by the
21 existence of an anticompetitive agreement, because when Defendants raised production a mere five
22 months later, they maintained prices at the same level as before the reduction in output. In other
23 words, Defendants' production and pricing behavior would only be consistent with competition if
24 incremental production costs had somehow been cut by a huge amount – 34 percent – over the
25 intervening five months. This could then possibly support an inference of competitive prices
26 remaining at the same levels when production returned to nearly the same levels. But as shown
27 below, input costs for Lithium Ion Batteries do not explain Defendants' pricing and production
28 behavior.

1 **D. The Structure and Characteristics of the Lithium Ion Battery Market Plausibly**
2 **Support the Alleged Conspiracy**

3 255. The structure and other characteristics of the Lithium Ion Battery market are
4 conducive to cartel behavior, and have made collusion particularly attractive in this market.
5 Specifically, the Lithium Ion Batteries market: (1) has high barriers to entry; (2) has inelasticity of
6 demand; (3) is highly concentrated; (4) features a high-level of contact among Defendants via trade
7 associations and industry conferences; and (5) is characterized by other features supportive of
8 collusion.

9 **1. The Lithium Ion Batteries Market Has High Barriers to Entry**

10 256. A collusive arrangement that raises product prices above competitive levels would,
11 under basic economic principles, attract new entrants seeking to benefit from the supra-competitive
12 pricing. Where, however, there are significant barriers to entry, new entrants are less likely. Thus,
13 barriers to entry help to facilitate the formation and maintenance of a cartel.

14 257. There are substantial barriers that preclude, reduce or make more difficult entry into
15 the Lithium Ion Batteries market. A new entrant into the business would face costly and lengthy
16 start-up costs, including multi-million dollar costs associated with research and development,
17 manufacturing plants and equipment, energy, transportation, distribution infrastructure, skilled labor
18 and long-standing customer relationships. As F.H. Sung, chairman and CEO of Simplo Technology
19 Co., Ltd., the Taiwanese battery pack manufacturer that is a major customer of Defendants and
20 discussed herein, aptly stated in December 2009, “No amateurs can make good batteries, especially
21 overnight, as the business calls for major investments and cutting-edge technologies.”¹⁴

22 258. It has been estimated that the cost to build a plant to manufacture Lithium Ion
23 Batteries that is capable of producing 3 million cells per month is approximately \$3 to \$4 per cell.
24 Thus, a plant making 3 million cells per month would cost approximately \$108 to \$144 million. This
25 estimate does not include the cost of research, development, and engineering that produced the
26 technology and equipment designs for the plant.

27 ¹⁴ *Simplo Technology CEO Self-promotes with Analysis of Li-ion Cell Biz*, Articlesbase
28 (Dec. 30, 2009), <http://www.articlesbase.com/electronics-articles/simplo-technology-ceo-selfpromotes-with-analysis-of-liion-cell-biz-1642348.html>.

1 259. In addition to the large costs of building a plant, given the nature of the materials used
2 in Lithium Ion Batteries, any new entrant will be required to comply with various environmental
3 regulations in whatever jurisdiction such plant is built. Compliance with such regulations will require
4 extensive testing and the receipt of government approvals, all of which will take many years.

5 260. Moreover, significant patent and/or licensing expenditures are a prerequisite to
6 competing in the industry. For example, Samsung stated the following in March 2000:

7 Samsung SDI plans to construct a cooperative relationship with its
8 affiliated companies and, together with the Samsung Advanced
9 institute of Technology, to obtain the basic core technology and
process technology which are necessary for the commercialization of
the battery.

10 Samsung SDI has secured a firm position in the battery industry by
11 obtaining access to the basic patents and technology for the lithium-
12 sulfur battery as well as the lithium-ion battery and the lithium-
13 polymer battery. This means that SDI has surpassed the replication
14 phase of other advanced products and has stepped into a new phase:
Samsung has secured, for the first time among Korean companies,
competitive and highly qualified technology and products to compete
with Japanese companies *that today hold hegemony in the worldwide
batteries market.*¹⁵

15 261. In April 2011, GoldSea Inc. reported that “Japan remains the undisputed leader in
16 battery technology, with 2,206 lithium-ion battery patents registered in the U.S., and two-thirds of all
17 patents in the field last year. The U.S. was second with 679 and Korea third with 463.”¹⁶

18 262. Other factors further limit new entrants. For example, in April 2012, Korea IT Times
19 reported that “China has yet to increase its market share because it has not attained a trusted brand
20 name, which is essential for success in the industry.”¹⁷ The U.S. Government’s Advanced
21 Technology Program (“ATP”) (part of the U.S. Department of Commerce’s National Institute of
22 Standards and Technology) stated the following in December 2006 report titled “Factors Affecting
23

24 ¹⁵ *Samsung SDI to Take an Equity Share in PolyPlus*, Samsung SDI (March 15, 2000),
25 <https://www.samsung.com/us/news/455>.

26 ¹⁶ *Japan, S. Korea in Tight Lithium-Ion Battery Race*, GoldSea Asian American Business,
<http://goldsea.com/Text/index.php?id=10735> (last visited June 30, 2013).

27 ¹⁷ Kim Sung-Mi, *Korean Secondary Battery Leaping 10 years, Overtaking Japan*, Korea IT
28 Times Global News Network (Apr. 27, 2012), <http://www.koreaitimes.com/story/21199/korean-secondary-battery-leaping-10-years-overtaking-japan>.

1 U.S. Production Decisions: Why are There No Volume Lithium-ion Battery Manufacturers in the
2 United States?":

3 Because of safety and performance considerations, Li-ion
4 manufacturers (except those in China) do not sell individual cells.
5 Japanese cell manufacturers sell only battery packs with safety devices
6 included. A battery pack can consist of a single cell, or multiple cells
7 connected in series or in parallel, to give the required voltage and
8 capacity. Individual cells from major Japanese manufacturers are
9 available only to outside pack assemblers on approval of their
10 electronic control circuitry in the pack.

11 Individual cells are available from Chinese manufacturers, but are
12 often of inferior quality. They often lack the usual safety features in
13 cell design and electronic controls and thus constitute some danger to
14 the public. This is not true for responsible manufacturers who try to
15 match the world standard of performance. The replacement market for
16 Li-ion cells is minimal. Of the purchasers of a new piece of equipment
17 such as a cell phone or a notebook computer, about 30 percent will buy
18 a second battery pack from the OEM. After that, replacement sales
19 account for less than 2 percent of total battery sales. People typically
20 buy a new, higher performance notebook computer about the time that
21 their old battery would need replacement.¹⁸

22 263. In a detailed July 20, 2012 investor report titled "*Lithium-ion batteries – A Japanese*
23 *tech growth story?*" Citi Research, a division of Citigroup Global Markets, Inc., informed its investor
24 clients that "We think that the local Chinese battery makers operate in a market that is basically
25 independent of the global lithium-ion battery market, as it is a low-end field which Japanese and
26 South Korean firms do not target and the major sources of demand, such as makers of 'white box'
27 goods, are in the gray zone." The report continued that "The big Chinese firms of BYD, BAK, and
28 Tianjin Lishen Battery have entered the consumer electronics battery market but they have quality
and technology issues. . . ."

29 264. In a 2008 presentation, Tesla Motors noted in a slide titled "Profitability of Li-ion
30 manufacturing" that "U.S. companies have difficulty justifying this commodity business (GE for
31 example) and that "[l]arge Asian manufacturers can justify this business by supporting related

32
33
34
35
36
37
38

¹⁸ Ralph J. Brodd, *Factors Affecting U.S. Production Decisions: Why are There No Volume Lithium-Ion Battery Manufacturers in the United States?* at 29-30 (Nat'l Inst. of Standards and Tech. ATP Working Paper Series, Working Paper 05-01, June 2005), available at <http://www.atp.nist.gov/eao/wp05-01/wp05-01.pdf>.

1 electronics divisions (cell phones, laptops, cameras, etc.) and through government support.”¹⁹

2 265. The U.S. Government’s ATP report further stated the following in December 2006:
3 “Success in the rechargeable market requires knowledge of the electrical requirements for emerging
4 products that use batteries as well as the ability to generate rapid product improvements to meet the
5 demand and then to assemble the unit cells into battery packs for use in the device. Most U.S.
6 producers have lacked this marketing and design/production infrastructure. Large Japanese vertically
7 integrated, consumer electronics companies have this infrastructure in place. These companies are
8 major players in both [the] primary and rechargeable battery industries.”²⁰ The report continued:

9 Japanese companies are geographically closer to other Asian markets
10 for selling their products, sourcing production, and working with other
11 makers of portable devices. The Japanese battery supplier is most often
12 part of a vertically integrated Japanese electronics company. Proximity
13 to the device designer gives them a significant advantage in developing
14 new products for the market. In the United States, major battery
15 producers are “on the outside looking in,” with limited access to or
16 understanding of the needs of portable electronic device
17 manufacturers. Device manufacturers such as Motorola and HP do not
18 share new product concepts and developments with U.S. battery
19 manufacturers.

20 It is even more difficult for U.S. manufacturers to identify new battery
21 requirements for devices that are being developed in Japan, the
22 heartland of portable device developments. The Japanese market is not
23 readily accessible to non-Japanese companies, making it very difficult
24 for U.S. battery manufacturers to act as suppliers of the batteries for
25 new products developed in Japan. As a result, the U.S. battery
26 manufacturers were unable to take advantage of the introduction of the
27 Li-ion battery to the portable device market in 1991.

28 * * *

The relationship of battery suppliers/manufacturers to the OEM
manufacturers of portable electronic devices follows two patterns. In
the vertically-integrated Japanese electronic companies, device
designers and battery groups are equal partners in developing leading
edge new products. The intensity of market competition in Japan has
resulted in the recognition by both groups that having batteries of the
highest capacity is critical to device sales. Designers of battery
components have advanced notice of the needs of the device designers.
They thus have time to develop a battery with special characteristics or

26 ¹⁹ JB Straubel, *Mobile Battery Market Overview*, Tesla Motors (Sept. 16, 2008),
27 <http://www.whitehouse.gov/files/documents/ostp/PCAST/PCAST%20Sep.%202008%20Straubel%20slides.pdf>.

28 ²⁰ See Brodd, *supra* note 19 (at 23).

1 offer an improved version of their present battery for incorporation into
2 the device.

3 This coordination between device designer and battery manufacturer
4 does not exist in the United States. Since new device designs constitute
5 very sensitive business information, the device designer will not share
6 detailed information on the battery needs with outside battery suppliers
7 until the device is almost ready for production. Once new device
8 designs are complete, OEMs specify battery requirements. They then
9 use their specification to purchase from suppliers worldwide, based on
10 price.

11 The relationship of U.S. battery manufacturers to device designers,
12 including U.S. cellular phone, notebook computer, and other wireless
13 manufacturers, is distant. The device designer imposes new product
14 requirements. The device manufacturers develop relatively detailed
15 battery performance specifications and buy against their specifications
16 on price. They also want at least two suppliers of each component to
17 have an assured supply to meet their needs. The battery manufacturers
18 have relatively little advance warning when a new cell size is required
19 for a new device. U.S. and European device manufacturers would buy
20 a battery product from U.S. suppliers if it were available and the cost
21 and performance were competitive.

22 All interviewees from U.S. battery manufacturers felt strongly that
23 device designers place the battery last in their designs. The cavity
24 provided for the battery is often an afterthought and undersized for the
25 expected performance. It often does not fit particular battery sizes and
26 shapes that are currently being manufactured.²¹

27 266. The ATP report continued as follows:

28 Since Japanese battery manufacturers are invariably part of large,
vertically integrated electronics corporations, their device designers
and battery developers readily share new product information. Early in
the product development cycle, the battery group has inside
information on the new requirements, sizes, and performance
specifications. Conversely, the device designer is aware of attainable
capabilities for battery performance. Each has time to respond to the
evolving needs of the other.²²

267. The ATP report continued as follows:

In markets for rechargeable batteries, customers are large, high-
technology-based electronics companies, typically having Li-ion
production within the same company. Developing a product requires
close contact with portable electronic device designers.

²¹ *Id.* at 25-26.

²² *Id.* at 29.

1 Huge investments have been made in Japan, Taiwan, South Korea, and
2 Southeast Asia in a global effort to capture the market for rechargeable
batteries for telecommunications, wireless, and computer products.²³

3 268. The ATP report continued as follows:

4 Sony, Matsushita, and Sanyo all had significant R&D programs in the
5 area, and each invested about \$150 million in production facilities in
6 quick succession. Starting in 1991, they invested heavily in production
capability; this investment continued throughout the decade and, in
some cases, amounted to as much as \$1 to \$2 billion or more.²⁴

7 **2. The Demand For Lithium Ion Batteries Is Inelastic**

8 269. “Elasticity” is a term used to describe the sensitivity of supply and demand to changes
9 in one or the other. For example, demand is said to be “elastic” if an increase in the price of a
10 product results in diminished revenues, with declines in the quantity sold of that product outweighing
11 the effects of higher prices on the value of sales. For products with a highly elastic demand, a price
12 increase results in a large drop in the value of sales. In other words, customers have many feasible
13 alternatives for cheaper products of similar quality, and so cut purchases sharply in the face of even a
14 small price increase.

15 270. For a cartel to profit from raising prices above competitive levels, market demand
16 must be relatively less elastic at competitive prices. That is, an increase in prices should not cause a
17 huge decline in demand. Otherwise, increased prices would result in sharply declining sales, as some
18 customers purchased substitute products or declined to buy altogether. A less elastic demand is a
19 market characteristic that facilitates collusion, allowing producers to raise their prices without
20 triggering customer substitution and sufficient lost sales revenues as to offset the beneficial effect of
21 higher prices on profits for products they still continue to sell.

22 271. Demand for Lithium Ion Batteries is not very elastic because there are no close
23 substitutes for these products.

24 **3. The Market For Lithium Ion Batteries Is Highly Concentrated**

25 272. Market concentration facilitates collusion. If an industry is divided into a large
26 number of small firms, the current gain from cheating on a cartel (profits from sales captured from

27 ²³ *Id.* at 47.

28 ²⁴ *Id.* at 71.

1 other cartel members through undercutting of the cartel-fixed price in the current time period, which
2 risks causing the cartel to fall apart in the future) is large relative to the firm's possible gains from
3 the cartel's continuing future success (the firm's future share of the total cartel profits if collusion
4 were to continue successfully). Conversely, with a more concentrated industry, a greater share for a
5 colluding firm in future cartel profits tips the balance in favor of continued collusion, and away from
6 any short-term, transitory bump in profits that could be achieved by undercutting the cartel price and
7 gaining a transitory increase in market share.

8 273. Empirical scholarship on cartels has primarily focused on a concentration measure
9 called the CR4 – the four-firm concentration ratio, the share of product sales accounted for by the
10 four largest firms – as a diagnostic in analyzing what levels of concentration facilitate multi-firm
11 collusion.²⁵

12 274. A seminal published study of the DOJ's price-fixing investigations found that 76
13 percent of these cartels occurred in sectors with CR4s of 50 percent or greater, which was about
14 double the average CR4 for manufacturing. Fully a quarter of these cartels therefore were still
15 organized in markets with a less than 50 percent share held by the four largest firms.²⁶

16 275. Figure 14 below shows that the CR4 exceeded 60 percent in the market for Lithium
17 Ion Batteries for all of the proposed class period, topping 80 percent in some years. The market share
18 of the alleged cartel members never fell below 70 percent, and reached to almost 90 percent in some
19 years.

20
21
22
23 ²⁵ The advantage of the CR₄ in predicting the relationship between concentration and the
24 likelihood of collusion is that it does not vary with the degree of asymmetry in an industry (unlike
25 the Herfindahl-Hirschman index (HHI), which as Motta notes, "confounds two factors – higher
26 average market share and asymmetry"). Motta observes that if "the measure of concentration does
27 not vary with asymmetry – as for the concentration ratios, C_k, that sum the market shares of the k
28 largest firms in the industry – then an increase in measured concentration should correspond to a
higher likelihood of collusion." Massimo Motta, *Competition Policy, Theory and Practice* 143
(Cambridge University Press 2004).

²⁶ See G.A. Hay & D. Kelley, *An Empirical Survey of Price-Fixing Conspiracies*, 17 *Journal of
Law and Economics* (1974).

Figure 14: Four-firm Concentration Ratios and Cartel Member Shares in the Lithium Ion Battery Industry

Global Li-Ion Battery Market Share Percentages

	2000 ¹	2005 ¹	2008 ²	2008 ³	2010 Q3 ²	2011 ³
Sanyo	33.0	28.0	22.0	23.0	20.0	
Panasonic	19.0	10.0	6.0	7.0	6.0	24.0
Samsung SDI	0.4	11.0	15.0	15.0	20.0	24.0
LG Chemical	1.3	6.5	7.0	7.0	14.0	16.0
Sony	21.0	13.0	15.0	14.0	11.0	8.0
BYD	2.9	7.5	8.0	9.0	5.0	5.0
BAK			7.0	6.0	6.0	4.0
TDK				4.0		4.0
Hitachi Maxell	3.4	3.3	5.0	4.0		3.0
Toshiba	11.0					
NEC TOKIN	6.4	3.6				
All Others	1.6	17.1	15.0	11.0	18.0	12.0
CR₄	84.0%	62.0%	60.0%	61.0%	65.0%	72.0%
alleged cartel members	89.1%	71.8%	70.0%	70.0%	71.0%	75.0%

Sources and Notes:

¹Market shares by value from METI (<http://www.meti.go.jp/english/information/downloadfiles/PressRelease/060828VehicleBatteries.pdf>).

²Market shares by value from January 26, 2011 Deutsche Bank Group report on LiB Materials Industry (citing METI and Nikkei Business Daily).

³Market shares by volume from July 20, 2012 Citi Research report on Lithium-ion Technology and Equities (citing TSR and Citi Research). Panasonic's 2011 market share contains Sanyo's (whom it merged with in 12/2009).

276. In a detailed July 20, 2012 investor report titled “*Lithium-ion batteries – A Japanese tech growth story?*” Citi Research, a division of Citigroup Global Markets, Inc., informed its investor clients that “The Big 3 of Panasonic, Samsung SDI, and LG Chem have a combined market share of over 60% and *the market is increasingly becoming an oligopoly.*” In a September 2011, 2008 article in the *Taipei Times*, Jackie Ding, the CFO of major Taiwanese packer Simplo Technology Co., one of Defendants’ primary customers, was quoted as stating “*All those cell players, what they do is control the market. . . . If it’s in oversupply status, then the oversupply will hurt them, while for us it will be an advantage.*”²⁷

4. Trade Associations, Industry Conferences and Other Common Forums Available to Facilitate Collusion

277. Defendants are members of numerous trade associations, and participate in numerous major industry trade shows, conferences, and seminars, providing Defendants with ample opportunities to further implement, facilitate, reinforce and monitor collusive activity under the guise of legitimate business undertakings, including travel and information exchanges.

²⁷ *Simplo Expects Cell Shortage to Last*, *Taipei Times* (Sep 11, 2008), <http://www.taipetimes.com/News/biz/archives/2008/09/11/2003422889>.

1 **a. Battery Association of Japan**

2 278. As noted herein, Japanese companies pioneered and initially dominated the world
3 market for Lithium Ion Batteries, and they formed trade associations to facilitate their activities. GS
4 Yuasa International Ltd., Hitachi Maxell, Ltd., NEC Energy Devices, Ltd., Panasonic Corporation,
5 Sony Corporation and Toshiba Corporation are listed as “Regular Members” of the “Battery
6 Association of Japan” (the “BAJ”).²⁸ The “Samsung Yokohama Research Institute” is listed as an
7 “Associate Member.”²⁹ The BAJ was formed in 1997 with the merger of the Japan Dry Batteries
8 Industries Association and the Japan Storage Battery Industries Association.³⁰ The BAJ states that
9 the “Main Products of the Regular Member Companies” include Lithium Ion Batteries.³¹

10 279. The BAJ lists its current Chairman as Mitsuru Homma,³² an Executive Director &
11 Executive Vice-President of Defendant Sanyo Electric Co., Ltd. and a member of the Board of
12 Directors of Defendant Panasonic Corporation.³³

13 280. The BAJ has a myriad of committees and subcommittees, such as the “Secondary
14 Battery Division,” the “Secondary Battery Division 2,” the “Standardization Committee,” the
15 “International Battery Standardization Committee,” the “Material Procurement Committee,” the
16 “Next Generation Storage Battery Committee,” the “Marketing Committee,” and the “Technology
17 Committee.”³⁴

18 281. The BAJ lists its “Main Tasks” as including the “standardization activities of battery
19 specifications,” which includes participating “in the TC21, the SC21A and the TC35 meetings as a
20

21 ²⁸ *BAJ Organization*, Battery Association of Japan,
<http://www.baj.or.jp/e/about/membership01.html> (last visited June 13, 2013).

22 ²⁹ *Associate Members of Battery Association of Japan*, Battery Association of Japan
<http://www.baj.or.jp/e/about/membership02.html> (last visited June 13, 2013).

23 ³⁰ *History of Batteries and BAJ*, Battery Association of Japan
24 <http://www.baj.or.jp/e/about/history.html> (last visited June 13, 2013).

25 ³¹ *Objective of the Battery Association of Japan (BAJ)*, Battery Association of Japan
<http://www.baj.or.jp/e/about/overview.html> (last visited June 13, 2013).

26 ³² *Id.*

27 ³³ *Members of the Board & Corporate Auditors*, Panasonic Corporation,
<http://panasonic.net/sanyo/corporate/profile/management.html> (last visited June 13, 2013).

28 ³⁴ *See BAJ Organization*, *supra* note 29.

1 member of the International Electrotechnical Commission (IEC), an international standards council,
2 and works to promote IEC standards.” The BAJ further acts as “Secretary of the Commission,
3 supervises the SC21A and TC35 meetings, and acts as the chair of the working group.”³⁵

4 282. The BAJ lists another of its “Main Tasks” as conducting “Statistical surveys on the
5 activities of battery industries” and that “surveys are conducted to track battery and appliance
6 production and distribution as well as battery consumption, and the information is published in the
7 BAJ newsletter and distributed to all types of publications and groups.”³⁶

8 283. The BAJ lists another of its “Main Tasks” as the “promotion of interchange activities
9 with relevant domestic and international organizations” and states that it “promotes the exchange of
10 information between domestic related industries as well as with the European and American battery
11 industries and the China battery association.”³⁷ The BAJ also lists, among it “Operations,” that it
12 “engages in the following activities to achieve its objective: . . . Association and cooperation with
13 external organizations involved with batteries and battery applied products.”³⁸

14 284. The BAJ further lists a catchall “Main Task” category of “Others,” which includes “to
15 actively promote all activities necessary for the development of the industry.”³⁹ The BAJ also states
16 that its operations include “[a] range of additional [activities] required to achieve the Association’s
17 objective other than those stated above.”⁴⁰

18 **b. Korean Battery Trade Associations**

19 285. Korea IT Times reported in April 2012 that Japan’s Institute of Information
20 Technology issued a report that “analyzed Samsung SDI’s success and how Korea overtook the
21 secondary batteries market” and that “gave Samsung SDI and LG Chem high marks for placing
22 Korea at the forefront of this industry by cooperating within the small rechargeable lithium-ion
23

24 ³⁵ *Overview of the Main Tasks of the Battery Association of Japan (BAJ)*, Battery Association
of Japan, <http://www.baj.or.jp/e/about/maintasks.html> (last visited June 13, 2013).

25 ³⁶ *Id.*

26 ³⁷ *Id.*

27 ³⁸ *See Objective of the Battery Association of Japan (BAJ)*, *supra* note 32.

28 ³⁹ *See Overview of the Main Tasks of the Battery Association of Japan (BAJ)*, *supra* note 36.

⁴⁰ *Id.*

1 batteries market.”⁴¹

2 286. In or about March 1997, the “Korea Battery Research Association” was formed,
3 including Samsung and LG. An offshoot formed in 2011 and discussed below, the “Korea Battery
4 Industry Association,” disseminated a slide presentation dated August 28th 2012, titled “Battery
5 Technology Commercialization Strategies in Korea” for the “Germany-Korea Electric-auto Battery
6 Technology Workshop.” The presentation analyzed the close ties formed as a result of the 1997
7 association formation, noting under heading titled “Factors that Made Korea’s Rechargeable battery
8 Industry the Global Leader” that there was “Cooperative R&D between materials, batters and
9 demand companies – link between development and commercialization” and that there was
10 “Continuous growth by ensuring stable demand from Samsung Electronics and LG Electronics.” The
11 presentation further notes that there was the “Formation of consortiums among research institutions,
12 materials, batteries, and demand companies.” The presentation further notes there was
13 “Reinforcement of cooperative systems between accessories, materials and battery companies for
14 maximization of investment synergy” and there was the “Expansion of exchanges through
15 technology exchanges [sic] seminars, promotion of custom cooperative R&D.”

16 287. The 2012 presentation continues, under a section titled “Stable Demand” that the
17 Korea “Possesses global mobile IT device companies such as SEC [Samsung] and [LGE] as captive
18 markets.”

19 288. In a report titled “*Next Generation Batteries: The Case of Korea*,” issued in
20 approximately 2003, Invest Korea, an investment arm of the Korea Trade-Investment Promotion
21 Agency, established in compliance with the Foreign Investment Promotion Act of 1998, stated that
22 “For the secondary industry to grow on a continuing basis, the government plans to establish a
23 Battery Industry Supporting Center, thereby forming a unified “window” for organic collaboration
24 among the industry, universities and research organizations and initiating efforts to develop
25 fundamental business such as technical evaluation and certification, development of parts, materials,

26
27 ⁴¹ Kim Sung-Mi, *Korean Secondary Battery Leaping 10 years, Overtaking Japan*, Korean IT
28 Times Global News Network (Apr. 27, 2012), <http://www.koreaitimes.com/story/21199/korean-secondary-battery-leaping-10-years-overtaking-japan>.

1 and equipment industries, human resource development, international cooperation, and provision of
 2 information.” The report further noted the Korea Government’s “plan to implement various
 3 supportive measures for the industry, including the development of a medium-term industrial plan by
 4 2008, to advance and create sustainable conditions for the battery and related industries.”

5 289. The “Korea Battery Industry Association” (“KBIA”) was formed in November 2011,
 6 and Defendant Samsung SDI Co. Ltd. states the following regarding it:

7 Samsung SDI’s CEO, Park Sangjin, was elected as the first chairman
 8 of the Korea Battery Industry Association, which was newly launched
 9 in November 2011. The Association has a membership of over 50
 companies both large and small, including Samsung SDI, LG Chem,
 SK innovation, GS Caltex, and L&F Materials.

10 At its inaugural meeting held on November 1st 2011, a “Mutual
 11 Development Council” was installed, and the members agreed to
 12 pursue mutual development through “3 Main Strategies and 7 Joint
 Projects”, which can be summarized as: patent-related cooperation;
 eschewing vertical integration; and collaborative R&D.

13 As the chair company of the Korea Battery Industry Association,
 14 Samsung SDI will take a leadership role and, with the support of the
 government, mediate between large companies and SMEs, thus
 15 contributing to a healthy environment for mutual growth.⁴²

16 290. The KBIA’s 2012 presentation, referenced above, continues that the “Main Projects in
 17 2012” include the “strengthening of global networks” and “Establishing MOUs with BAJ (Japan)
 18 and CIBA (China).”

19 **c. Other Trade Associations**

20 291. The “PRBA – Rechargeable Battery Association” (“PBRA”) was originally
 21 established in 1991 as the “Portable Rechargeable Battery Association” to develop battery recycling
 22 programs. Panasonic and Sanyo were among its founding members.⁴³ Officer of Panasonic, Sanyo
 23 and Sony sit on the organization’s board of directors,⁴⁴ and it counts Maxell, Panasonic Battery, and
 24

25 ⁴² *Official Institutes & Public Associations: Public Policy Response and Participation*,
 Samsung SDI, http://www.samsungsdi.com/sustain/s2_7.jsp (last visited June 14, 2013).

26 ⁴³ *About PRBA*, Portable Rechargeable Battery Association, <http://www.prba.org/about-prba/>
 27 (last visited June 30, 2013).

28 ⁴⁴ *Board of Directors at PRBA*, Portable Rechargeable Battery Association,
<http://www.prba.org/about-prba/>board-of-directors/> (last visited June 14, 2013).

1 Samsung SDI among its members.⁴⁵ It now acts as the “voice of the Rechargeable Power Industry,
 2 representing its members on legislative, regulatory and standards issues at the state, federal and
 3 international level.”⁴⁶ It states that it “provides reports, newsletters and other information to keep its
 4 members informed of the latest activities and issues affecting the rechargeable power industries.”⁴⁷
 5 The PRBA further states that it “has a long-standing and successful working relationship with the
 6 Battery Association of Japan (BAJ)” and that it “works closely with its counterparts in Europe and
 7 coordinates its efforts with several European battery trade associations including, RECHARGE,
 8 Eurobat, European Portable Battery Association and European Battery Recycling Association.”⁴⁸

9 292. “Battery Power” is an annual conference in existence for more than a decade, to be
 10 held in Colorado this year, and it bills itself as “an international conference highlighting the latest
 11 developments and technologies in the battery industry.”⁴⁹ The conference “is designed for OEM
 12 design engineers and system engineers involved in battery powered products and systems and power
 13 management technology, as well as battery pack and cell manufacturers.”⁵⁰ This year’s attendees are
 14 listed as including Samsung and Panasonic.

15 293. “Battery Japan” bills itself as the “world’s largest trade show for rechargeable
 16 batteries,” and is a concurrent exhibition and technical conferences. Representatives of Sanyo, Sony
 17 and Panasonic all participated as Committee Members for the 2011 Conference, and Samsung was
 18 listed as among the 2013 exhibitors.

19 **E. Government Investigations into a Lithium Ion Batteries Cartel**

20 294. A globally coordinated antitrust investigation is taking place in at least the United
 21 States and Europe, aimed at manufacturers of Lithium Ion Batteries. In the United States, as detailed

22 ⁴⁵ *Membership*, Portable Rechargeable Battery Association
 23 <http://www.prba.org/membership/membership-directory/> (last visited June 14, 2013).

24 ⁴⁶ *Powering the Future*, Portable Rechargeable Battery Association, <http://www.prba.org/> (last
 visited June 14, 2013).

25 ⁴⁷ *See About PRBA*, *supra* note 44.

26 ⁴⁸ *Benefits of Membership of PRBA*, Portable Rechargeable Battery Association
<http://www.prba.org/membership/benefits-of-membership> (last visited June 14, 2013).

27 ⁴⁹ Battery Power 2013, <http://www.batterypoweronline.com/conferences/> (last visited June 14,
 2013).

28 ⁵⁰ *Id.*

1 below, two Defendants – Sanyo Electric Co., Ltd. and LG Chem, Ltd. – have now pled guilty to the
2 criminal price-fixing of Lithium Ion Batteries.

3 295. In or around June 2011, defendant Sony Corporation disclosed that its wholly owned
4 U.S. subsidiary – Sony Electronics, Inc. – received a subpoena from the DOJ concerning its
5 “secondary batteries” business. Specifically, Sony disclosed that:

6 In May 2011, Sony Corporation’s U.S. subsidiary, Sony Electronics
7 Inc., received a subpoena from the U.S. Department of Justice (“DOJ”) Antitrust Division seeking information about its secondary batteries
8 business.

9 Sony understands that the DOJ is investigating competition in the
10 secondary batteries market. Based on the stage of the proceeding, it
11 is not possible to estimate the amount of loss or range of possible
12 loss, if any, that might result from adverse judgments, settlements or
13 other resolution of this matter.⁵¹

14 296. On or about June 27, 2012, Sony issued its SEC Form 20-F for its fiscal year ended
15 March 31, 2012, disclosing an apparent expansion of the investigation and stating that “DOJ and
16 agencies outside the United States are investigating competition in the secondary batteries market.”

17 297. Around the same time as its initial disclosure of the governmental investigation,
18 according to a Korean news article, a source from the DOJ confirmed that it was conducting a
19 criminal investigation into potential price fixing with respect to the sale of secondary batteries in the
20 United States and has been since the first half of 2011. The same article quoted the source as stating
21 that criminal charges are likely to be filed.

22 298. On or about August 20, 2012, LG Chem confirmed that it also was the target of the
23 investigation being conducted by the DOJ. As detailed below, LG Chem subsequently pled guilty.

24 299. Other news articles have confirmed that in addition to defendants Sony and LG Chem,
25 Samsung SDI and Panasonic are also under investigation by the DOJ for price fixing with respect to
26 the sale of rechargeable batteries.

27 300. On April 17, 2013, defense counsel for Hitachi in the present case wrote to counsel
28 for plaintiffs and confirmed that MCA [Maxell Corporation of America] received a subpoena on

⁵¹ Sony Corporation SEC Form 20-F for fiscal year ending March 31, 2011, filed June 28, 2011.

1 April 29, 2011 from the Antitrust Division of the DOJ. Hitachi’s letter also referenced “two state
2 Attorneys General investigating the LIB [lithium ion battery] business” and further referenced
3 Hitachi’s receipt of “Civil Investigative Demands issued by [the Attorneys General] offices.”

4 301. On November 7, 2012, Defendants confirmed in writing to the Judicial Panel on
5 Multidistrict Litigation that they “are informed and believe that a grand jury of the Northern District
6 of California is conducting an antitrust investigation into the pricing of lithium ion batteries, and the
7 San Francisco field office of the Antitrust Division of the DOJ is leading that effort.”⁵²

8 **1. The Criminal Guilty Pleas of Sanyo Electric Co., Ltd. and LG Chem, Ltd.**

9 **a. Sanyo Electric Co. Ltd.’s Criminal Guilty Plea**

10 302. On September 3, 2013, the DOJ filed with this Court a criminal “Plea Agreement”
11 entered into and signed by Defendant Sanyo Electric Co., Ltd. This Plea Agreement included the
12 following:

- 13 ▪ [D]efendant will waive indictment and plead guilty to a one-count Information to be
14 filed in the United States District Court for the Northern District of California. The
15 Information will charge the defendant with participating in conspiracy to suppress and
16 eliminate competition by fixing the prices of cylindrical lithium ion battery cells sold
17 in the United States and elsewhere for use in notebook battery packs from about April
18 2007 to about September 2008, in violation of the Sherman Antitrust Act, 15 U.S.C. §
19 1.
- 20 ▪ The defendant will plead guilty to the criminal charge described in Paragraph 2 above
21 pursuant to the terms of this Plea Agreement and will make a factual admission of
22 guilt to the Court . . .”
- 23 ▪ Had this case gone to trial, the United States would have presented evidence sufficient
24 to prove the following facts . . . During the relevant period, [Matsushita Electric
25 Industrial Co., Ltd.] and Sanyo Electric . . . participated in a conspiracy with other
26 persons and entities engaged in the manufacture and sale of cylindrical lithium ion
27 battery cells, the primary purpose of which was to fix the prices of cylindrical lithium
28 ion battery cells sold in the United States and elsewhere for notebook computer
battery packs.”

52 *In re: Lithium Ion Batteries Antitrust Litigation*, Responses of Certain Defendants to Motion of Plaintiff Woodrow Clark II for the Transfer of Related Actions to the District of New Jersey for Coordinated or Consolidated Pretrial Proceedings Pursuant to 28 U.S.C. § 1407, at 7 MDL No. 2420 (J.P.M.L. 2012), ECF No. 33, Nov. 7, 2012 (filed by Samsung SDI America, Inc., LG Chem America, Inc., Sony Electronics Inc., Panasonic Corporation of North America, Sanyo North American Corporation, Samsung Electronics America, Inc., and Maxell Corporation of America).

- 1 ▪ Acts in furtherance of this conspiracy were carried out within the Northern District of
2 California. Cylindrical lithium ion battery cells used in notebook computer battery
3 packs and battery packs containing the price-fixed cells that were the subjects of this
4 conspiracy were sold by one or more of the conspirators to customers in this District.”
- 5 ▪ The defendant and the defendant’s parent, Panasonic, and the subsidiaries of the
6 defendant and Panasonic (collectively, “related entities”) will cooperate fully and
7 truthfully with the United States in the prosecution of this case, the current federal
8 investigation of violations of federal antitrust and related criminal laws involving the
9 manufacture or sale of cylindrical lithium ion battery cells . . . For purposes of this
10 Plea Agreement, subsidiaries are entities in which the defendant or Panasonic, directly
11 or indirectly, had a greater than 50% ownership interest as of the date of signature of
12 this Plea Agreement.
- 13 ▪ [T]he United States agrees that it will not bring further criminal charges against the
14 defendant or any of its related entities for any act or offense committed before the
15 date of this Plea Agreement that was undertaken in furtherance of an antitrust
16 conspiracy involving the manufacture or sale of cylindrical lithium ion battery cells.

17 303. The one-count criminal Information referenced above states the following among
18 other things:

- 19 For the purpose of forming and carrying out the charged combination and conspiracy,
20 the defendant and its co-conspirators did those things that they combined and
21 conspired to do, including, among other things:
- 22 (a) participating in meetings, conversations, and communications in Korea, Japan, and
23 elsewhere to discuss the prices of cylindrical lithium ion battery cells for use in
24 notebook computer battery packs;
 - 25 (b) agreeing, during those meetings, conversations, and communications, to charge prices
26 of cylindrical lithium ion battery cells for use in notebook computer battery packs at
27 certain predetermined levels;
 - 28 (c) issuing price quotations in accordance with the agreements reached;
 - (d) collecting and exchanging information on prices and sales of cylindrical lithium ion
 battery cells for the purpose of monitoring and enforcing adherence to the agreed-
 upon prices;
 - (e) authorizing, ordering, and consenting to the participation of subordinate employees in
 the conspiracy; and
 - (f) taking steps to conceal the conspiracy and conspiratorial contacts, conversations, and
 communications through various means.

1 304. On October 01, 2013, this Court entered a “Judgment in a Criminal Case,” stating that
2 Sanyo Electric Co. Ltd. “pleaded guilty to count One of the Information” and that it “is adjudicated
3 guilty of these offenses: 15 U.S.C. section 1 Price Fixing”

4 **b. LG Chem Ltd.’s Guilty Plea Agreement**

5 305. On September 3, 2013, the DOJ filed with this Court a criminal “Plea Agreement”
6 entered into and signed by Defendant LG Chem, Ltd. This Plea Agreement included the following:

- 7 ▪ [D]efendant will waive indictment and plead guilty to a one-count Information to be
8 filed in the Unites States District Court for the Northern District of California. The
9 Information will charge the defendant with participating in conspiracy to suppress and
10 eliminate competition by fixing the prices of cylindrical lithium ion battery cells sold
11 in the United States and elsewhere for use in notebook battery packs from about April
12 2007 to about September 2008, in violation of the Sherman Antitrust Act, 15 U.S.C. §
13 1.
- 14 ▪ The defendant will plead guilty to the criminal charge described in Paragraph 2 above
15 pursuant to the terms of this Plea Agreement and will make a factual admission of
16 guilt to the Court . . .”
- 17 ▪ Had this case gone to trial, the United States would have presented evidence sufficient
18 to prove the following facts . . . During the relevant period, [LG Chem Ltd.]. . .
19 participated in a conspiracy with other persons and entities engaged in the
20 manufacture and sale of cylindrical lithium ion battery cells, the primary purpose of
21 which was to fix the prices of cylindrical lithium ion battery cells sold in the United
22 States and elsewhere for notebook computer battery packs.”
- 23 ▪ Acts in furtherance of this conspiracy were carried out within the Northern District of
24 California. Cylindrical lithium ion battery cells used in notebook computer battery
25 packs and battery packs containing the price-fixed cells that were the subjects of this
26 conspiracy were sold by one or more of the conspirators to customers in this District.”
- 27 ▪ The defendant and its subsidiaries will cooperate fully and truthfully with the United
28 States in the prosecution of this case, the current federal investigation of violations of
federal antitrust and related criminal laws involving the manufacture or sale of
cylindrical lithium ion battery cells . . . The defendant’s subsidiaries for purposes of
this Plea Agreement are entities in which the defendant had a greater than 50%
ownership interest as of the date of signature of this Plea Agreement.
- [T]he United States agrees that it will not bring further criminal charges against the
defendant or any of its subsidiaries for any act or offense committed before the date of
this Plea Agreement that was undertaken in furtherance of an antitrust conspiracy
involving the manufacture or sale of cylindrical lithium ion battery cells.

1 306. The one-count criminal Information referenced above states the following among
2 other things:

3 For the purpose of forming and carrying out the charged combination and conspiracy,
4 the defendant and its co-conspirators did those things that they combined and
5 conspired to do, including, among other things:

- 6 (a) participating in meetings, conversations, and communications in Korea, Japan, and
7 elsewhere to discuss the prices of cylindrical lithium ion battery cells for use in
8 notebook computer battery packs;
- 9 (b) agreeing, during those meetings, conversations, and communications, to charge prices
10 of cylindrical lithium ion battery cells for use in notebook computer battery packs at
11 certain predetermined levels;
- 12 (c) issuing price quotations in accordance with the agreements reached;
- 13 (d) collecting and exchanging information on prices and sales of cylindrical lithium ion
14 battery cells for the purpose of monitoring and enforcing adherence to the agreed-
15 upon prices;
- 16 (e) authorizing, ordering, and consenting to the participation of subordinate employees in
17 the conspiracy; and
- 18 (f) taking steps to conceal the conspiracy and conspiratorial contacts, conversations, and
19 communications through various means.

20 307. On October 10, 2013, this Court conducted a hearing regarding LG Chem Ltd.'s
21 guilty plea, and asked LG Chem Ltd. through its corporate representative Heung Ryu Yoon, General
22 Counsel and Vice President, the following questions and received the following answers:

23 **THE COURT:** And it is true that high-level personnel of LG Chem
24 did participate in a conspiracy that he identified?

25 **THE DEFENDANT:** (Through the interpreter) Yes.

26 (Pause in the proceedings.)

27 **THE COURT:** Approximately how many discussions or meetings
28 occurred? (Translation by the interpreter.)

THE COURT: Just an approximation.

THE DEFENDANT: (Through the interpreter) About 20 or 30.

THE COURT: And can you describe generally what is meant by
"high-level personnel"?

1 **THE DEFENDANT:** (Through the interpreter) I'm referring to the
2 officers within the Battery Division.

3 308. On October 15, 2013, this Court entered a "Judgment in a Criminal Case," stating that
4 LG Chem Ltd. "pleaded guilty to count 1 of the Information" and that it "is adjudicated guilty of
5 these offenses: 15 U.S.C. section 1 Price Fixing"

6 **F. Defendants Have a History of Conspiring to Fix Prices for Critical Components of
7 Consumer Electronics**

8 309. Many of the Defendants have a long history of criminal collusion and are either
9 currently involved in worldwide investigations into other technology-related products or have been
10 convicted of participating in price fixing cartels involving technology-related products. Further,
11 much of the illegal conduct to which the Defendants or their affiliates have admitted to, took place
12 during the Class Period identified in this complaint.

13 310. Notably, the Lithium Investing News, which identifies itself as a "source for
14 unbiased, independent news and information on the lithium market," evaluated the allegations in the
15 initial complaint in this matter, wrote that the "*allegations aren't far fetched*" and noted that
16 "[e]lectronics companies have been the subject of several price-fixing investigations conducted by
17 the United States and the European Union in recent years." (emphasis added).⁵³

18 311. A notebook computer contains four key pieces of hardware: a dynamic random access
19 memory (DRAM) chip, a liquid crystal display (LCD) screen, an optical disk drive (ODD), and a
20 rechargeable lithium-ion battery. Defendants here have pled guilty to fixing the prices of the first
21 three of these components, and the DOJ is investigating whether to bring criminal price-fixing
22 charges for the fourth component - Lithium Ion Batteries.

23 312. In a detailed July 20, 2012 investor report titled "*Lithium-ion batteries – A Japanese
24 tech growth story?*" Citi Research, a division of Citigroup Global Markets, Inc., wrote to investor
25 clients that "We think that behind the advance of South Korean firms lie many of the same
26 ingredients that led to their success in semiconductor memory and LCD panels."

27 ⁵³ Melissa Pistilli, *Lithium Battery Manufacturers Accused of Price Fixing*, Lithium Investing
28 News (Nov. 12, 2012), <http://lithiuminvestingnews.com/6599/lithium-ion-battery-manufacturers-accused-price-fixing-electric-vehicles-lawsuit/>.

1 313. That success in fact came about by illegal means, as in the present case. For example,
2 In or around October 2005, Samsung Electronics Company, Ltd. and Samsung Semiconductor, Inc.
3 agreed to plead guilty and pay a \$300 million fine for “participating in an international conspiracy to
4 fix prices in the [Dynamic Random Access Memory] market” Samsung Electronics Company,
5 Ltd. and Samsung Semiconductor, Inc. admitted that they participated in the conspiracy from
6 approximately April 1, 1999 through June 15, 2002. In addition, seven Samsung executives (Il Ung
7 Kim, Sun Woo Lee, Yeongho Kang, Young Woo Lee, Thomas Quinn, Young Hwan Park, Young
8 Bae Rha) agreed to plead guilty to participating in the conspiracy with respect to DRAM. Each
9 agreed to pay a \$250,000 criminal fine and serve a prison sentence in the United States ranging from
10 seven to fourteen months.

11 314. Although it has not been publicly acknowledged, it is widely believed that Samsung is
12 in the DOJ leniency program with respect to the DOJ’s investigation into the market for LCDs,
13 meaning that it has admitted its participation in the cartel.

14 315. In November 2008, LG Display Co., Ltd., a wholly owned Korean subsidiary of LG
15 Electronics, agreed to plead guilty and pay a \$400 million fine to the United States, in connection
16 with its participation in a worldwide conspiracy to fix the prices of LCDs during the period from
17 September 2001 through June 2006. At the time, the fine paid by LG was the second highest fine
18 ever imposed by the Antitrust Division of the DOJ. In addition, in April 2009, an executive of LG
19 Display, Bock Kwon, agreed to plead guilty to participating in the global LCD conspiracy from
20 September 2001 through June 2006. Kwon, a Korean national, agreed to serve 12 months in a U.S.
21 prison and pay a \$30,000 criminal fine. Further, in February 2009, another LG Display executive,
22 Duk Mo Koo, agreed to plead guilty to participating in the global conspiracy with respect to LCDs
23 from September 2001 through December 2006.

24 316. In March 2009, Hitachi Displays, Ltd., a wholly owned Japanese subsidiary of
25 Hitachi, Ltd., agreed to plead guilty and pay a \$31 million fine for participating in a worldwide
26 conspiracy to fix the prices of LCDs during the period April 1, 2011 through March 31, 2004.

27 317. In September 2011, an entity which is a joint venture between Hitachi, Ltd. and LG
28 Electronics, Inc. - Hitachi-LG Data Storage, Inc. - agreed to plead guilty and pay a \$21.1 million fine

1 for participating in various conspiracies to rig bids and fix prices for ODDs during the period from
2 June 2004 through September 2009. In addition, three Hitachi-LG Data Storage executives also
3 agreed to plead guilty for participating in the same conspiracy. In December 2011, Yong Kuen Park,
4 Sang Hun Kim, and Sik Hur agreed to plead guilty for participating in the conspiracy with respect to
5 ODDs during the period November 2005 through September 2009. All three agreed to serve prison
6 time in the United States and pay criminal fines.

7 318. Defendants have also entered guilty pleas for fixing prices for other high-tech
8 products.

9 319. In or around March 2011, Defendant Samsung SDI, Company, Ltd. agreed to plead
10 guilty and pay a \$32 million fine for participating in a “global conspiracy to fix prices, reduce output,
11 and allocate market share of color display tubes, a type of cathode ray tube used in computer
12 monitors and other specialized applications” Samsung SDI Company Ltd. admitted it
13 participated in the conspiracy from approximately January 1997 through at least March 2006.

14 320. In September 2010, Defendant Panasonic Corporation agreed to plead guilty and pay
15 a \$49.1 million fine for participating in a conspiracy to “suppress and eliminate competition by
16 fixing prices to customers of household compressors” during the period October 14, 2004
17 through December 31, 2007.

18 321. Certain defendants in the present litigation are also defendants in other civil
19 consolidated antitrust litigations pending in this district and related to the above criminal matters.
20 Plaintiffs in these actions allege that defendants, as in the present action, colluded to illegally fix the
21 prices of certain products including computer components. For example, Defendants in two of the
22 actions have produced documents relevant to the present case and that evidence Defendants’
23 collusive conduct with respect to Lithium Ion Batteries. These actions are captioned: (1) *In re*
24 *Optical Disk Drive Products Antitrust Litig.*, Case No. 3:10-md-2143 RS (“*ODD* Litigation”), and
25 (2) *In re Cathode Ray Tube (CRT) Antitrust Litig.*, Case No. C 07-5944 SC, MDL No. 1917 (“*CRT*
26 Litigation”).

27 322. The following is a chart detailing the overlapping and related defendants among the
28 present case, the *ODD* Litigation, and the *CRT* Litigation:

PRESENT CASE RE: LITHIUM ION BATTERIES	ODD ANTITRUST LITIGATION	CRT ANTITRUST LITIGATION
LG Chem, Ltd. LG Chem America, Inc.	LG Electronics, Inc. Hitachi-LG Data Storage, Inc. Hitachi-LG Data Storage Korea, Inc.	LG Electronics, Inc. LG Electronics Taiwan Taipei Co., Ltd. LG Electronics USA, Inc.
Panasonic Corporation Panasonic Corporation of North America	Panasonic Corporation Panasonic Corporation of North America	Panasonic Corporation Panasonic Corporation of North America
Sony Corporation Sony Energy Devices Corporation Sony Electronics, Inc.	Sony Corporation	--
Samsung SDI Co., Ltd. Samsung SDI America, Inc.	Samsung Electronics Co., Ltd.	Samsung SDI Co., Ltd. Samsung SDI America, Inc.
Hitachi, Ltd. Hitachi Maxell, Ltd.	Hitachi, Ltd.	Hitachi, Ltd.

IV. THE ROLE OF THE PACKER COMPANIES IN THE INDUSTRY.

323. Three Taiwanese companies, known as “packers,” acquire battery cells from Defendants, assemble them into battery “packs” and then supply the packs to manufacturers of laptop computers, cell phones, and the other consumer electronics devices discussed herein.

A. Simplo Technology Co., Ltd.

324. Simplo is a publicly-traded company based in Taiwan. In 2010, a news report stated that “Simplo is the world’s large notebook PC battery pack maker now. Last year, some 160 million notebook PCs were sold worldwide, with one out of every five adopting the firm’s battery packs on average ... the firm scored banner sales revenue of US \$1.07 billion.”⁵⁴ Another 2010 news report

⁵⁴ *Simplo to Keep Dominating Global Battery Modules This Year*, Cens.com, http://cens.com/cens/html/en/news/news_inner_31685.html (last visited June 13, 2013).

1 stated that “Simplo has commanded a 22-23% share of the global market for notebook PC battery
 2 packs, only next to Sanyo’s 24%. However, institutional investors indicated that Simplo, with orders
 3 from new customers serving as a growth drive [sic], is very likely to boost its market share to over
 4 30% to outpace the Japanese competitor in 2011.”⁵⁵

5 325. Simplo’s website indicates that it was founded in April of 1992 and that at the time its
 6 “Main operating items were Ni-mh Battery Pack and Li-ion Pack for Notebooks.”⁵⁶ Simplo further
 7 states that in October 2003 it was “Certified by DELL.”⁵⁷ It references its products as including the
 8 following: “Battery Pack of Notebook,” “Battery Pack of Tablet PC,” “Battery Pack of Cell
 9 Phone/Smart Phone,” “Battery Pack of GPS,” “Battery Pack of Cable Modem,” “Battery Pack of E-
 10 Bike/ E-Scooter/ Power Wheelchair,” “Other specialized battery pack,” and “Trade of battery
 11 pack.”⁵⁸ Simplo further lists its “Customers” as including Apple, Dell, HP, Acer, Compal, FIC,
 12 Inventec, Quanta, Uniwill, Arima, MSI, Clevo, LGE, Twinhead, and Wistron.⁵⁹ A March 2012
 13 article in the Taipei Times stated that “Simplo supplies battery packs to 30 clients in laptop and
 14 tablet-related areas, covering all the major firms, except for Samsung Electronics Co., [Simplo
 15 Chairman and CEO Raymond] Sung said.”⁶⁰

16 326. Simplo’s chairman and CEO F.H. Sung was quoted in December 2009 as stating that
 17 Simplo had “delivered hundreds of millions of battery packs for different industrial applications.”⁶¹
 18 Reports from earlier in the Class Period further reinforce the massive volume of relevant commerce
 19 flowing through Simplo. In April 2005, a news report stated that “Simplo and DynaPack, Taiwan’s
 20

21 ⁵⁵ *Simplo Aims to Unseat Sanyo as World’s Largest Battery Pack Supplier in 2011*, Cens.com,
http://cens.com/cens/html/en/news/news_inner_34553.html (last visited June 13, 2013).

22 ⁵⁶ *Company Profile*, Simplo Technology Co., Ltd., <http://www.simplo.com.tw/company.htm>
 23 (last visited June 13, 2013).

24 ⁵⁷ *Id.*

25 ⁵⁸ *Id.*

26 ⁵⁹ *Id.*

27 ⁶⁰ Lisa Wang, *Simplo Posts Its Strongest Profits in Six Quarters*, Taipei Times (March 10,
 28 2012), <http://www.taipeitimes.com/News/biz/archives/2012/03/10/2003527393>.

⁶¹ *Simplo Technology CEO Self-promotes with Analysis of Li-ion Cell Biz*, Articlesbase
 (Dec. 30, 2009), [http://www.articlesbase.com/electronics-articles/simplo-technology-ceo-
 selfpromotes-with-analysis-of-liion-cell-biz-1642348.html](http://www.articlesbase.com/electronics-articles/simplo-technology-ceo-selfpromotes-with-analysis-of-liion-cell-biz-1642348.html).

1 two leading manufacturers of notebook computer battery modules, see their combined share of the
 2 global market run close to 30%. Simplo is very likely to unseat Sanyo of Japan as the world's largest
 3 producer in the line this year."⁶² The 2005 report continued that "Simplo said it would see shipments
 4 reach 11 million battery modules for a 20% global market share this year, compared with last year's
 5 17%" and that "Simplo president Sung Fu-hsiang said his company shipped 7.5 million lithium
 6 battery modules for a 17% global market share last year, only behind Sanyo of Japan."⁶³

7 327. In December 2003, a news report regarding Simplo stated that "[t]he company
 8 estimated it would ship 2.4 million NB batteries to Hewlett Packard this year, accounting for 44% of
 9 its total shipments of 5.25 million units. The company anticipated it would see shipment grow to 8.6
 10 million NB batteries next year" and that "[w]ith the orders from Dell and Hewlett Packard, Simplo
 11 vows to become the world's second largest manufacturer of NB batteries next year, with its global
 12 market share to expand to between 18% and 20% from the existing 13.8%."⁶⁴

13 B. Celxpert

14 328. Celxpert states on its website that "Since its founding in 1997, [it] has experienced
 15 incredible growth" and that "its customers base [sic] on the rapidly evolving notebook computer,
 16 cellular phone and handheld device markets. . . ."⁶⁵ and that it is "a dedicated developer and
 17 manufacturer of battery packs for portable and handheld devices."⁶⁶ Celxpert's website further states
 18 that in January of 1999, it "[b]egan technical Notebook Battery Pack Development with NEC
 19 (Japan)" and that in 2010 it "[e]nter[ed] Tablet PC market," that in 2011 it "[e]nter[ed] Ultrabook
 20 market," and that in 2012 it "[e]nter Power Tool, ESS market."⁶⁷

22 ⁶² *Taiwan's Notebook Battery Makers Enjoying Rising Global Market Shares*, Cens.com
 (Apr. 11, 2005), http://cens.com/cens/html/en/news/news_inner_10191.html.

23 ⁶³ *Id.*

24 ⁶⁴ *Simplo Obtains Dell Orders for NB Battery*, Cens.com (Dec. 22, 2003),
http://cens.com/cens/html/en/news/news_inner_11540.html.

25 ⁶⁵ *About Us/ Management for Growth*, Celxpert Energy Corporation,
<http://www.celxpert.com.tw/eng/p1-1.asp> (last visited June 13, 2013).

26 ⁶⁶ *About Us/ Company History*, Celxpert Energy Corporation,
<http://www.celxpert.com.tw/eng/p1-2.asp> (last visited June 13, 2013).

27 ⁶⁷ *Id.*

1 329. Celxpert’s website states that its “Competence & Strength” includes “[s]igning
2 cooperate contract with major cell vendors. Keep the supply steady. Signing supply contract with our
3 chiefly NB [notebook] and Cellular phone customers and signed long term contract with major cell
4 vendors to assure the supply.”⁶⁸ It further notes its competence and strength as including
5 “[s]tandardization of manufactory [sic] procedure and production.”⁶⁹ Celxpert’s website lists its
6 “Vendors” as including Panasonic, Samsung SDI, Maxell, NEC / Tokin, Sony and LG Chem.⁷⁰
7 Celxpert’s website lists its “Customer[s]” as including Asus, Blackberry, Lenovo, Hitachi, Pegatron,
8 Unihan, Samsung, LG, Quanta, Compal, and Clevo.⁷¹

9 330. On its website, Celxpert presently makes available what appears to be a translated
10 news article dated December 29, 2003, that quotes Celxpert’s President as stating “Now the lithium
11 cells, direct material of battery packs mainly in flowed by Japan and Korea suppliers. Due to mutual
12 understanding between these parties, we have got the firmly committed support based on long-term
13 cooperation.”⁷²

14 C. **Dynapack**

15 331. Dynapack states on its website that it was founded in 1998 and at that time it’s
16 “[m]ain operating items include Ni-MH BatteryPack, Li-ION BatteryPack for Notebook and
17 CellPhone.”⁷³ It further states that in March 2001 “BatteryPack for Notebook accumulated
18 production volume has been broken through one million sets” and that in March 2002 “BatteryPack
19 for Notebook accumulated production volume has been broken through two million sets.”⁷⁴
20 Dynapack provides on its website information appearing to indicate the identity of at least some of

21 _____
22 ⁶⁸ *About Us/ Competence and Strength*, Celxpert Energy Corporation, <http://www.celxpert.com.tw/eng/p1-3.asp> (last visited June 13, 2013).

23 ⁶⁹ *Id.*

24 ⁷⁰ *Customer*, Celxpert Energy Corporation, <http://www.celxpert.com.tw/eng/p5-1.asp> (last
visited June 13, 2013).

25 ⁷¹ *Id.*

26 ⁷² *New Release*, Celxpert Energy Corporation, [http://www.celxpert.com.tw/eng/news-
1a.asp?num=36](http://www.celxpert.com.tw/eng/news-1a.asp?num=36) (last visited June 13, 2013).

27 ⁷³ *About DynaPack/ Milestone*, DynaPack, <http://www.dynapack.com.tw/englisg/> (last visited
June 13, 2013).

28 ⁷⁴ *Id.*

1 its customers and/or suppliers. For the time period “2001-2008” it states it “Passed Apple
 2 Qualification,” “Passed HP Qualification,” “Passed Dell Qualification,” “Passed MPE
 3 Qualification,” “Passed SONY Green Partners management system Audit,” “Passed ASUS, LG,
 4 HTC Qualification,” “Passed ODM, OEM Customers Qualification eg: Quanta, Compal,
 5 Inventec ...” (ellipsis in original).⁷⁵ For 2009, Dynapack makes similar representations about
 6 qualification and audits for some of the same companies, as well as “Passed Wistron Annual Audit,”
 7 “Passed SEC Qualification Audit” [presumably Samsung].” For 2010, Dynapack again made similar
 8 representations, as well as “Passed Pegatron Qualification Audit,” and “Passed Delta Qualification
 9 Audit.” Similar representations were made for 2011.

10 332. A February 2010 news report indicated that Dynapack “is expected to ship over 6
 11 million battery packs to Apple for the entire year.”⁷⁶ An April 2005 news report stated that
 12 “Dynapack will aim to ship 4.53 million battery modules to raise market share to 8.24% this year
 13 from last year’s 5.8%.”⁷⁷

14 V. MANNER AND MEANS OF THE CONSPIRACY

15 333. For purposes of forming and carrying out the charged combination and conspiracy,
 16 Defendants did those things that they combined and conspired to do, including, among other things:

- 17 a. participating in meetings, conversations and communications in the United
 18 States, Japan, Korea and elsewhere to discuss the prices of Lithium Ion Batteries in the United States
 19 and elsewhere;
- 20 b. agreeing, during those meetings, conversations and communications, on prices
 21 for Lithium Ion Batteries sold in the United States and elsewhere;
- 22 c. agreeing, during those meetings, conversations and communications, to
 23 depress the supply of Lithium Ion Batteries;

25 ⁷⁵ *Id.*

26 ⁷⁶ *Simplo, Dynapack to See Auspicious Year in 2010*, Cens.com (Feb. 3, 2010),
 27 http://cens.com/cens/html/en/news/news_inner_31131.html.

28 ⁷⁷ *Simplo Obtains Dell Orders for NB Battery*, Cens.com (Dec. 22, 2003),
http://cens.com/cens/html/en/news/news_inner_11540.html.

- 1 d. agreeing, during those meetings, conversations and communications, to
- 2 coordinate prices for Lithium Ion Batteries sold in the United States and elsewhere;
- 3 e. selling Lithium Ion Batteries in the United States and elsewhere at collusive
- 4 and noncompetitive prices;
- 5 f. accepting payment for Lithium Ion Batteries at collusive and noncompetitive
- 6 prices;
- 7 g. engaging in meetings, conversations and communications in the United States
- 8 and elsewhere for the purpose of monitoring and enforcing adherence to the agreed-upon price-fixing
- 9 scheme; and
- 10 h. employing measures to keep their conduct secret.

11 **VI. THE INFLATED PRICES OF LITHIUM ION BATTERIES WERE PASSED**
12 **THROUGH TO CONSUMERS**

13 334. Defendants' conspiracy to raise, fix, or maintain the price of Lithium Ion Batteries at
14 artificial levels resulted in harm to Plaintiffs and the Classes because it resulted in them paying
15 higher prices for Lithium Ion Battery Products than they would have in the absence of Defendants'
16 conspiracy.

17 335. Lithium Ion Batteries are commodity-like products with functionally equivalent
18 products available from Defendants. Defendants manufacture Lithium Ion Batteries pursuant to
19 standard specifications.

20 336. A Lithium Ion Battery is purchased by a consumer as a stand-alone product, or as a
21 substantial part of a Lithium Ion Battery Product. When a Lithium Ion Battery is purchased by
22 consumers as a stand-alone product, the battery or the cell inside the battery itself is directly
23 traceable to the specific manufacturing defendant. When a Lithium Ion Battery is purchased as part
24 of a Lithium Ion Battery Product, it is a distinct, physically discrete element of the end-use product
25 and is identifiable by a specific, discrete part or model number that permits tracing. Lithium Ion
26 Batteries are traceable and identifiable throughout the chain of distribution to the end user. They do
27 not undergo any physical alterations as they move through the chain of distribution.

1 337. The purchaser buys a Lithium Ion Battery either from the direct purchaser OEM or
2 through a reseller such as a retailer. Thus, a Lithium Ion Battery follows a traceable physical chain
3 from the Defendants to the OEMs, to the purchaser of the Lithium Ion Battery Product. Tracing can
4 help show that changes in the prices paid by direct purchasers of Lithium Ion Batteries affect prices
5 paid by indirect purchasers of the Lithium Ion Batteries themselves, or Lithium Ion Battery Products.

6 338. The OEM and the retail markets of Lithium Ion Batteries and Lithium Ion Battery
7 Products are subject to vigorous price competition. The direct purchaser OEMs and retailers have
8 very thin net margins. They are therefore at the mercy of their component costs, such that increases
9 in the price of Lithium Ion Batteries lead to quick, corresponding price increases at the OEM and
10 retail levels for Lithium Ion Batteries and Lithium Ion Battery Products.

11 339. As a result, the inflated prices of Lithium Ion Batteries resulting from Defendants'
12 price fixing conspiracy have been passed on to Plaintiffs and the Classes by direct purchasers,
13 manufacturers, distributors and retailers.

14 340. Lithium Ion Batteries make up a substantial component cost of Lithium Ion Battery
15 Products. The retail price of a Lithium Ion Battery Product is determined in substantial part by the
16 cost of the Lithium Ion Battery it contains.

17 341. Thus, Plaintiffs and members of the Classes have been forced to pay supra-
18 competitive prices for Lithium Ion Batteries and Lithium Ion Battery Products. These inflated prices
19 have been passed on to them by direct purchaser manufacturers, distributors and retailers.

20 342. Lithium Ion Batteries are identifiable, discrete physical products that remain
21 essentially unchanged when incorporated into a Lithium Ion Battery Product. As a result, Lithium
22 Ion Batteries follow a traceable physical chain of distribution from the Defendants to Plaintiffs and
23 the members of the Classes, and any costs attributable to Lithium Ion Batteries can be traced through
24 the chain of distribution to Plaintiffs and the members of the Classes.

25 343. Just as Lithium Ion Batteries can be physically traced through the supply chain, so can
26 their price be traced to show that changes in the prices paid by direct purchasers of Lithium Ion
27 Batteries affect prices paid by indirect purchasers of Lithium Ion Battery Products and Lithium Ion
28 Batteries.

1 344. While even a monopolist would increase its prices when the cost of its inputs
2 increased, the economic necessity of passing through cost changes increases with the degree of
3 competition a firm faces. The markets for Lithium Ion Battery Products are subject to vigorous price
4 competition. The direct purchasers of Lithium Ion Batteries have thin net margins, and are therefore
5 at the mercy of their component costs, such that increases in the price of components such as Lithium
6 Ion Batteries lead to corresponding increases in prices for Lithium Ion Battery Products at the
7 consumer level. When downstream distribution markets are highly competitive, as they are in the
8 case of Lithium Ion Battery Products, overcharges are passed through to ultimate consumers, such as
9 the indirect-purchaser Plaintiffs and class members.

10 345. Hence the inflated prices of Lithium Ion Batteries have been passed on to Plaintiffs
11 and other class members.

12 346. The economic and legal literature has recognized that unlawful overcharges in a
13 component normally result in higher prices for products containing that price-fixed component. Two
14 antitrust scholars – Professors Robert G. Harris (Professor Emeritus and former Chair of the Business
15 and Public Policy Group at the Haas School of Business at the University of California at Berkeley)
16 and the late Lawrence A. Sullivan (Professor of Law Emeritus at Southwestern Law School and
17 author of the Handbook of the Law of Antitrust) – have observed that “in a multiple- level chain of
18 distribution, passing on monopoly overcharges is not the exception: it is the rule.

19 347. As Professor Jeffrey K. MacKie-Mason (Arthur W. Burks Professor for Information
20 and Computer Science and Professor of Economics and Public Certification), an economist who
21 presented evidence in a number of indirect purchaser cases involving Microsoft Corporation, said (in
22 a passage quoted in the judicial decision in that case granting class certification):

23 As is well known in economic theory and practice, at least some of the
24 overcharge will be passed on by distributors to end consumers. When
25 the distribution markets are highly competitive, as they are here, all or
26 nearly the entire overcharge will be passed on through to ultimate
27 consumers...Both of Microsoft’s experts also agree upon the economic
28 phenomenon of cost pass through, and how it works in competitive
markets. This general phenomenon of cost pass through is well
established in antitrust laws and economics as well.

1 348. The purpose of the conspiratorial conduct of the Defendants and their co- conspirators
2 was to raise, fix, rig or stabilize the price of Lithium Ion Batteries and as a direct and foreseeable
3 result, the price of Lithium Ion Battery Products. Economists have developed techniques to isolate
4 and understand the relationship between one “explanatory” variable and a “dependent” variable in
5 those cases when changes in the dependent variable are explained by changes in a multitude of
6 variables, even when all such variables may be changing simultaneously. That analysis - called
7 regression analysis - is commonly used in the real world and in litigation to determine the impact of a
8 price increase on one cost in a product (or service) that is an assemblage of costs. Thus, it is possible
9 to isolate and identify only the impact of an increase in the price of Lithium Ion Battery prices for
10 Lithium Ion Battery Products even though such products contain a number of other components
11 whose prices may be changing over time. A regression model can explain how variation in the price
12 of Lithium Ion Batteries affects changes in the price of Lithium Ion Battery Product. In such models,
13 the price of Lithium Ion Batteries would be treated as an independent or explanatory variable. The
14 model can isolate how changes in the price of Lithium Ion Batteries impact the price of Lithium Ion
15 Battery Products while controlling for the impact of other price-determining factors.

16 349. The precise amount of the overcharge impacting the prices of Lithium Ion Batteries
17 and Lithium Ion Battery Products can be measured and quantified. Commonly used and well-
18 accepted economic models can be used to measure both the extent and the amount of the supra-
19 competitive charge passed-through the chain of distribution. Thus, the economic harm to Plaintiffs
20 and class members can be quantified.

21 **VII. ANTITRUST INJURY**

22 350. The effect of Defendants’ conduct as described herein has been to artificially inflate
23 the prices paid by Plaintiffs and members of the Classes for Lithium Ion Batteries and Lithium Ion
24 Battery Products.

1 **VIII. PLAINTIFFS' CLAIMS ARE NOT BARRED BY THE STATUTE OF LIMITATIONS**

2 **A. The Statute of Limitations Did Not Begin to Run Because Plaintiffs Did Not and Could**
3 **Not Discover Their Claims**

4 351. Plaintiffs and Class Members had no knowledge of the combination or conspiracy
5 alleged herein, or of facts sufficient to place them on inquiry notice of the claims set forth herein,
6 until (at the earliest) June 2011, when reports of the investigations into anticompetitive conduct
7 concerning Lithium-Ion Batteries were first publicly disseminated. Even then, these reports lacked
8 detail and were not widely disseminated. For example, Sony in June 2011 disclosed only that it
9 "received a subpoena from the U.S. Department of Justice ("DOJ") Antitrust Division seeking
10 information about its secondary batteries business" and that it "understands that the DOJ is
11 investigating competition in the secondary batteries market." This cryptic statement lacked any
12 specifics as to the "who, what, where, when, why and how" of any potential unlawful activity.

13 352. Plaintiffs and Class Members are purchasers who indirectly purchased for their own
14 use and not for resale either a Lithium Ion Battery manufactured by a Defendant and/or a Lithium
15 Ion Battery Product containing a Lithium Ion Battery manufactured by a Defendant. They had no
16 direct contact or interaction with any of the Defendants in this case and had no means from which
17 they could have discovered the combination and conspiracy described in this Complaint before June
18 2011, when reports of the investigations into anticompetitive conduct concerning Lithium-Ion
19 Batteries were first publicly disseminated.

20 353. No information in the public domain was available to Plaintiffs and the Class
21 Members prior to the public announcements of the government investigations beginning in May
22 2011 that revealed sufficient information to suggest that any one of the Defendants was involved in a
23 criminal conspiracy to fix prices for Lithium Ion Batteries.

24 354. Publicly, Defendants repeatedly and expressly stated throughout the Class Period,
25 including on their public Internet websites, that they maintained antitrust / fair competition policies
26 which prohibited the type of collusion seen in this litigation. For example:

27 **Samsung:** In its "Global Code of Conduct," dated January 2006 ("Code of Conduct")
28 Samsung publicly stated that "This Global Code of Conduct will be the

1 guiding standard for everyone in Samsung Electronics, outlining standards of
 2 conduct in all business activities.”⁷⁸

- 3 • Samsung publicly stated that it “will not enter into price fixing, bid collusion,
 4 market collusion or reduced production agreements with competitors, and will
 5 not discuss with competitors prices, bids, customers, sales territories and
 6 conditions including price confirmation.”⁷⁹
- 7 • Samsung further publicly stated that it “will compete freely and fairly at all its
 8 business sites around the world, abiding by relevant international standards
 9 and national, state and local laws, with the laws of the host jurisdiction
 10 prevailing.”⁸⁰
- 11 • Samsung further publicly stated in its Code of Conduct that one of the five
 12 “Samsung Values” was “Integrity,” and one of the “7 Factors of a World
 13 Leading Company” was “Trust & Credibility.”⁸¹

14 **Sony:**

Sony publicly stated on its website that “In May 2003, Sony adopted the Sony
 Group Code of Conduct, which sets the basic internal standards to be observed
 by all directors, officers and employees of the Sony Group . . . The Code of
 Conduct has been adopted and implemented by each Sony Group company
 globally and is the subject of frequent ‘tone from the top’ messaging and other
 training.”⁸²

- 15 • Sony in its “Sony Group Code of Conduct” (“Code of Conduct”) stated:

16 **3.3 Fair Competition**

17 It is the policy of Sony Group to comply with all applicable antitrust,
 18 competition and fair trade laws and regulations of each country and
 19 region where Sony Group conducts business. These laws and
 20 regulations are designed to prohibit agreements or undertakings *vis-à-*
 21 *vis* third parties that fix prices, divide markets, limit production or
 22 otherwise impede or destroy market forces. Some countries or regions
 23 have antitrust or competition laws that assert extraterritorial
 24 jurisdictions over certain activities taking place outside the jurisdictions

25 ⁷⁸ *Global Code of Conduct* at 2, 2006.1, Samsung Electronics Co., Ltd.,
 26 [http://www.samsung.com/us/aboutsamsung_bkup_20110627/ir/corporategovernance/globalcodeofco](http://www.samsung.com/us/aboutsamsung_bkup_20110627/ir/corporategovernance/globalcodeofconduct/IR_GlobalPrinciple0.html)
 27 [nduct/IR_GlobalPrinciple0.html](http://www.samsung.com/us/aboutsamsung_bkup_20110627/ir/corporategovernance/globalcodeofconduct/IR_GlobalPrinciple0.html) (last visited June 30, 2013).

28 ⁷⁹ *Id.* at 6.

⁸⁰ *Id.*

⁸¹ *Id.* at 2.

⁸² *Sony Group Code of Conduct*, Sony,
http://www.sony.net/SonyInfo/csr_report/compliance/index2.html (last visited June 30, 2013).

1 if they affect the markets of those jurisdictions. All Personnel must
2 know and comply with those laws and regulations applicable to their
3 jobs.

4 **Sanyo:** Sanyo Electric Co., Ltd., in its “Code of Conduct and Ethics,” listed with an
5 establishment date of April 1, 2006, publicly stated: “Free Competition and
6 Fair Commercial Transactions – We will conduct our business activities
7 lawfully and with fairness and transparency.

8 We will not unfairly limit free competition which would include not making
9 arrangements with others in the same trade about product prices, volumes,
10 manufacturing facilities, and market share.

11 We will not involve ourselves in bid-rigging to decide the winning bidder and
12 contract price in bidding.”

- 13 • Sanyo further publicly stated that “We will carry on our business activities in
14 compliance with the laws regulations and rules of each country and region in
15 which we operate and those prescribed specifically for respective business
16 categories.”

17 **LG:** LG, in its “LG Electronics Code of Conduct,”⁸³ issued in 2009, publicly stated
18 that “Our Standard” was to “not accept competitor information directly from a
19 competitor. Not only would this be an illegitimate way to gather competitive
20 information, information-sharing with a competitor also could suggest that an
21 improper agreement exists between competitors.”

- 22 • LG further stated in a section titled “Fair Competition: Dealing with
23 Competitors,” that “We want to be respectful of our competitors and avoid
24 situations that suggest improper interactions. In general, relationships among
25 competitors can cause problems with fair competition. Our first duty is to
26 serve our customers. We serve them by supporting the rules that encourage
27 our continued innovation and success in a strong, competitive market.”
- 28 • LG further publicly stated that “Our Standard” is “Do not enter into any
contract, agreement or formal, informal or implied understanding with a
competitor without legal staff approval. Seek proper guidance before
encouraging the Company to follow a competitor’s activities.”
- LG further publicly stated that “Our relationships ultimately should focus on
serving our customers and working effectively with our business partners, not
unfairly restricting fair trade.”

⁸³ *Creating Value for Our Stakeholders, The LG Electronics Code of Conduct*, LG Electronics (2009).

- 1 • LG publicly stated that “In 1994, LG Electronics took the initiative in
 2 practicing fair and transparent management when it became the first private
 3 company in Korea to publish an ethical code (LG Electronics Code of Ethics).
 4 In the following year, the company announced its Management by Principle
 5 which elaborates on its ethical code. In 2004, the ‘LG Code of Ethics’ and ‘LG
 6 Code of Ethics Guidelines for Practice’ were established to clearly define the
 7 company’s high standards of ethical behavior and practices to employees.”
- 8 • In its “LG Code of Ethics,” LG publicly stated “It is our intention to uphold
 9 the principle [sic] of free market economy, which embodies the spirit of fair
 10 competition . . . we regard our customers as the primary standard for our
 11 decisions and conducts [sic] . . . We are always truthful to our customers, and
 12 are bound to keep our promises . . . Chapter 2. Fair Competition . . . 1. Pursuit
 13 of Free Competition. We uphold the principle of the free market economic
 14 system. Therefore we pursue free competition, and earn our customers’ trust . .
 15 . We compete fairly and capably with our competitors . . . We conduct our
 16 domestic and overseas business activities in strict accordance with local laws
 17 and regulations”

12 **Hitachi:** Hitachi in its “Code of Conduct,” dated April 5, 2010, publicly stated that
 13 “[t]he Hitachi Group Codes of Conduct have been established as specific
 14 codes of conduct that apply to all companies of the Hitachi Group.”⁸⁴

- 15 • Hitachi further publicly stated that “We will observe domestic and overseas
 16 competition laws and regulations as a matter of course and act appropriately as
 17 a member of society under the basic principles of conduct according to the
 18 rule of law and ethical corporate integrity and fair, transparent and free
 19 competition.”⁸⁵
- 20 • In 2006, Hitachi-Maxell publicly issued its “Corporate Social Responsibility
 21 Report,” stated that its “Code of Conduct” was issued in June 1983 and
 22 included as its first statement that “We will comply with the laws and
 23 regulations of the countries in which we operate and observe corporate ethics.”
- 24 • Hitachi-Maxell further publicly stated in its 2006 report that one of the items
 25 in its “Hitachi Maxell Group Ethical Guidelines” was that “We will engage in
 26 fair, transparent and free competition, and will maintain sound and ethical
 27 relations with government and administrative bodies” and that “We will reject
 28 all contact with organizations involved in activities in violation of the law or
 in violation of accepted standards of responsible social behavior.”

27 ⁸⁴ *Code of Conduct*, Hitachi, <http://www.hitachi.com/about/corporate/conduct/index.html> (last
 28 visited June 30, 2013).

⁸⁵ *Id.*

1
2
3
4
5
6
7
8
9
10
11
12
13
14
15
16
17
18
19
20
21
22
23
24
25
26
27
28

- Hitachi further publicly stated in its 2006 Report: “[Ensuring Fair and Free Competition] In the interest of proactively preventing any violation of the Antimonopoly Law, in January 2006 a revised edition of the Antimonopoly Law Handbook (Hitachi Group) was distributed to employees, who are urged to adhere rigorously to its content.”

Panasonic: Panasonic, in its “Panasonic Code of Conduct,” in place through the Class Period, publicly stated that “No matter how severe the competition may be, we will pursue fair and ethical marketing activities in compliance with all applicable laws and regulations. In other words, we will never violate any laws, regulations or social norms in pursuit of greater sales or profit.

We will not engage in bribery, collusion on bids, price fixing or other cartel activities.”

- Panasonic further publicly stated that “we will respect free and fair competition, and abide by all applicable antitrust (competition law) and other laws and regulations” and that “We will fulfill our tasks by always observing not only applicable laws and regulations, but also the highest standards of business ethics” and “We will conduct business with integrity, a law-abiding spirit, and the highest ethical standards.”

NEC: NEC, in its “Code of Conduct,”⁸⁶ publicly stated throughout the Class Period, including to this day on its website, the following:

- “3.2 Free Competition and Fair Commercial Transactions
- (1) WE will conduct fair commercial transactions with all business partners based on the principle of free competition and in compliance with anti-trust, competition and fair trade laws and all other applicable laws, rules and regulations
- (2) WE will not undertake any action that inhibits free and fair competition, including collusion and cartel formation, nor will we participate in meetings or in exchanges of information that may limit free competition or engage in any activity that may be construed as doing so.
- (3) WE will always keep relations with customers, business partners and competitors, open and fair. In addition, we will carry out all commercial transactions with integrity by adhering to social ethics.”

Toshiba: Toshiba publicly stated in its 2008 Annual Report that “Compliance programs covering Antitrust Law and code of conduct covering sales to government and public offices have been introduced, and all sales personnel get dedicated

⁸⁶ *NEC Group Code of Conduct*, NEC, <http://www.nec.com/en/global/csr/management/code.html#sec3> (last visited July 2, 2013).

training in these areas.”⁸⁷ Toshiba presently and publicly states on its website the following, and has done so since at least as early as August 2010:

- “Directors and Employees shall:
 1. follow sound and fair business practices in all dealings with customers;
 2. promote marketing and sales that comply with all applicable laws and regulations, observe sound business practices and respect socially accepted ideas;
 3. observe the SOC on “Competition Law” and endeavor to practice and promote free and fair competition;

* * *

• **7. Competition Law**

1. Toshiba Group Corporate Policy

Toshiba Group Companies shall:

1. comply with any and all laws and regulations enacted for the purpose of maintaining free and fair competition (hereinafter called “Competition Laws”); and

* * *

• **2. SOC for Toshiba Group Directors and Employees**

Directors and Employees shall:

1. observe the Competition Laws compliance programs as well as the company rules on marketing activities toward governmental agencies and promote free and fair business activities;
2. avoid agreements or understandings with competitors relating to pricing (including quotations and bids), the volume of production and sales, allocation of markets, customers or territories, or restrictions on production capacities or technology. The prohibition of such agreements is not limited to those actually recorded in writing by way of memoranda or minutes, but also extends to oral agreements;
4. not engage in activities or organize or participate in meetings, make pledges or arrangements, or exchange information which may be a cause of concern in respect of paragraphs 2 and 3 above, or engage in any related

* * *

⁸⁷ Toshiba Corporation Annual Report 2008 at 43 (2008), available at <http://www.toshiba.co.jp/about/ir/en/finance/ar/ar2008.htm>

1 activities or activities which may result in suspicion of engaging in such
2 activities”⁸⁸

3 355. It was reasonable for Class members who may have been exposed to these public
4 policies to believe that the Defendants were enforcing the policies.

5 356. For these reasons, the statute of limitations as to Plaintiffs and the Classes’ claims did
6 not begin to run, and has been tolled with respect to the claims that Plaintiffs and Class Members
7 have alleged in this Complaint.

8 **B. Fraudulent Concealment Tolled the Statute of Limitations**

9 357. In the alternative, application of the doctrine of fraudulent concealment tolled the
10 statute of limitations on the claims asserted herein by Plaintiffs and the Classes. Plaintiffs and Class
11 Members did not discover, and could not discover through the exercise of reasonable diligence, the
12 existence of the conspiracy alleged herein until June 2011, when reports of the investigations into
13 anticompetitive conduct concerning Lithium-Ion Batteries were first publicly disseminated.

14 358. Before that time, Plaintiffs and Class Members were unaware of Defendants’
15 unlawful conduct, and did not know before then that they were paying supra-competitive prices for
16 Lithium Ion Batteries throughout the United States during the Class Period. No information, actual or
17 constructive, was ever made available to Plaintiffs that even hinted to Plaintiffs that they were being
18 injured by Defendants’ unlawful conduct.

19 359. The affirmative acts of Defendants alleged herein, including acts in furtherance of the
20 conspiracy, were wrongfully concealed and carried out in a manner that precluded detection.

21 360. Plaintiffs have detailed herein the Defendants’ use of mechanisms designed to conceal
22 their collusion, such as covert meetings, use of code words or terms to refer to competitors and/or
23 customers, use of pretexts to mask the true purpose of collusive communications, use of non-
24 company phones, and instructions to destroy emails evidencing collusive activities.

25 361. By its very nature, Defendants’ anticompetitive conspiracy was inherently self-
26 concealing. Lithium Ion Batteries are not exempt from antitrust regulation, and thus, before May

27 ⁸⁸ *Toshiba Group Standards of Conduct*, Wayback Machine
28 <http://web.archive.org/web/20100815060506/http://www.toshiba.co.jp/csr/en/policy/soc.htm> (last
visited July 2, 2013).

1 2011, Plaintiffs reasonably considered it to be a competitive industry. Accordingly, a reasonable
2 person under the circumstances would not have been alerted to begin to investigate the legitimacy of
3 Defendants' Lithium Ion Battery prices before May 2011.

4 362. Plaintiffs and Class Members could not have discovered the alleged contract,
5 conspiracy or combination at an earlier date by the exercise of reasonable diligence because of the
6 deceptive practices and techniques of secrecy employed by Defendants and their co-conspirators to
7 avoid detection of, and fraudulently conceal, their contract, combination, or conspiracy.

8 363. Because the alleged conspiracy was both self-concealing and affirmatively concealed
9 by Defendants and their co-conspirators, Plaintiffs and Class Members had no knowledge of the
10 alleged conspiracy, or of any facts or information that would have caused a reasonably diligent
11 person to investigate whether a conspiracy existed, until June 2011, when reports of the
12 investigations into anticompetitive conduct concerning Lithium Ion Batteries were first publicly
13 disseminated.

14 364. For these reasons, the statute of limitations applicable to Plaintiffs' and Class
15 Members' claims was tolled and did not begin to run until, at the earliest, June 2011.

16 **IX. TRADE AND COMMERCE AFFECTED BY DEFENDANTS' CONSPIRACY**

17 365. During the Class Period, Defendants collectively controlled the vast majority of the
18 market for Lithium Ion Batteries, both globally and in the United States.

19 366. Defendants sold Lithium Ion Batteries and Lithium Ion Battery Products to
20 manufacturers and consumers, located in numerous states in the United States other than states in
21 which Defendants are located, substantial quantities of Lithium Ion Batteries and Lithium Ion
22 Battery Products shipped from outside the United States and from other states in a continuous and
23 uninterrupted flow of interstate and foreign trade and commerce.

24 367. In addition, substantial quantities of equipment and supplies necessary to the
25 production and distribution of Lithium Ion Batteries and Lithium Ion Battery Products, as well as
26 payments for Lithium Ion Batteries and Lithium Ion Battery Products and related products sold by
27 Defendants, traveled in interstate and foreign trade and commerce. The business activities of
28 Defendants in connection with the production and sale of Lithium Ion Batteries and Lithium Ion

1 Battery Products that were the subject of the charged conspiracy were within the flow of, and
2 substantially affected, interstate and foreign trade and commerce.

3 **A. Defendants' Conduct Involved Import Trade or Import Commerce**

4 368. Defendants' illegal conduct involved U.S. import trade or import commerce.
5 Defendants knowingly and intentionally sent price-fixed Lithium Ion Batteries into a stream of
6 commerce that they knew led directly into the United States, one of their most important markets and
7 a major source of their revenues. In this respect, they directed their anticompetitive conduct at
8 imports into the United States with the intent of causing price-fixed Lithium Ion Batteries to enter the
9 United States market and inflating the prices of Lithium Ion Battery Products destined for the United
10 States. Such conduct was meant to produce and did in fact produce a substantial effect in the United
11 States in the form of higher prices.

12 369. The U.S. Lithium Ion Battery market is enormous and was a major focus of and very
13 important to the conspiracy. Defendants and others shipped millions of Lithium-Ion Batteries,
14 including those incorporated into finished products, into the United States during the Class Period for
15 ultimate resale to U.S. consumers. As a result, a substantial portion of Defendants' revenues were
16 derived from the U.S. market. Defendants spent hundreds of millions of dollars on advertising their
17 products in the United States.

18 370. Because of the importance of the U.S. market to Defendants and their co-conspirators,
19 Lithium Ion Batteries and products containing Lithium Ion Batteries intended for importation into
20 and ultimate consumption in the United States were a focus of Defendants' illegal conduct.
21 Defendants knowingly and intentionally sent price-fixed Lithium Ion Batteries and products
22 containing Lithium Ion Batteries into a stream of commerce that lead directly into the United States.
23 Many Lithium Ion Batteries were intended for incorporation into finished products specifically
24 destined for sale and use in the United States. This conduct by Defendants was meant to produce and
25 did in fact produce a substantial effect in the United States in the form of artificially-inflated prices
26 for Lithium Ion Batteries and products containing Lithium Ion Batteries.

27 371. During the Class Period, every Defendant shipped Lithium Ion Batteries directly into
28 the United States.

1 372. When high-level executives based at Defendants’ Asian headquarters agreed on
2 prices, they knew that their price-fixed Lithium Ion Batteries would be incorporated into products
3 containing Lithium Ion Batteries sold in the United States. Moreover, because Lithium Ion Batteries
4 are – and were throughout the Class Period – a significant component of products containing Lithium
5 Ion Batteries, Defendants knew that price increases for Lithium Ion Batteries would necessarily
6 result in increased prices for products containing Lithium Ion Batteries sold in the United States.
7 Many Defendants manufactured products containing Lithium Ion Batteries and sold them in the
8 United States.

9 373. For the reasons set forth above, Defendants’ illegal conduct involved import trade or
10 import commerce into the United States.

11 **B. Defendants’ Conduct Had a Direct, Substantial, and Reasonably Foreseeable Effect on**
12 **U.S. Domestic and Import Trade or Commerce That Gave Rise to Plaintiffs’ Antitrust**
13 **Claims**

14 374. Plaintiffs and Class Members are located all across the United States, including
15 Arizona, California, Florida, Illinois, Kansas, Maine, Massachusetts, Michigan, Minnesota,
16 Mississippi, Missouri, Nebraska, Nevada, New York, Oregon, South Dakota, Tennessee, West
17 Virginia, and Wisconsin.

18 375. Defendants’ illegal conduct had a direct, substantial, and reasonably foreseeable effect
19 on U.S. domestic and import trade or commerce in the form of higher prices for Lithium Ion
20 Batteries and products containing Lithium Ion Batteries (prices that were the product of collusion)
21 that Plaintiffs and Class Members paid. These prices, tainted by collusion, directly and immediately
22 impacted Plaintiffs and Class Members in the United States. In this respect, the U.S. effects of
23 Defendants’ illegal conduct gave rise to Plaintiffs’ and Class Members’ antitrust claims and were the
24 proximate cause of the injury that Plaintiffs and Class Members suffered.

25 376. A number of facts demonstrate that Defendants’ price-fixing conspiracy had a direct,
26 substantial and reasonably foreseeable effect on domestic commerce. For example, Samsung
27 presently has posted on its website a news article titled “Samsung SDI to Supply Batteries to Dell,
28 HP,” dated April 29, 2008, stating that “Samsung SDI, the world’ [sic] No. 3 maker of secondary
cells, plans to supply its latest lithium-ion batteries to U.S.-based computer makers including Dell

1 and Hewlett-Packard (HP) from July this year. ‘Recently, we finalized a deal with some U.S.-based
2 leading computer makers to supply our lithium-ion batteries,’ Samsung SDI said Tuesday.’⁸⁹

3 377. The Taiwanese packer Simplo is one of Defendants’ major customers. It states on its
4 website that its major customers for battery packs include U.S.-based laptop computer and consumer
5 electronics manufacturers Apple, Dell, and HP. In December 2003, a news report regarding Simplo
6 stated that “[t]he company estimated it would ship 2.4 million NB batteries to Hewlett Packard this
7 year, accounting for 44% of its total shipments of 5.25 million units. The company anticipated it
8 would see shipment grow to 8.6 million NB batteries next year” and that “[w]ith the orders from Dell
9 and Hewlett Packard, Simplo vows to become the world’s second largest manufacturer of NB
10 batteries next year, with its global market share to expand to between 18% and 20% from the
11 existing 13.8%.”⁹⁰

12 378. The Taiwanese packer Dynapack is one of Defendants’ major customers. A February
13 2010 news report indicated that Dynapack “is expected to ship over 6 million battery packs to Apple
14 for the entire year.”⁹¹

15 379. Defendants are the dominant suppliers of Lithium Ion Batteries to the major U.S.-
16 based computer manufacturers, such as HP, Dell, and Apple, as well as other massive computer
17 manufacturers whose products are leading brands in the U.S. The following chart from a leading
18 battery industry research and consulting company, Avicenne Energy, details many Defendants’ shares
19 of the leading computer manufacturers’ Lithium Ion Battery needs for portable computers in 2011.

20 380. The leading portable computer manufacturers, many of whom are listed above,
21 dominate the United States market. The following chart illustrates their market shares of Laptop
22 sales as well as estimates the percentage of sales of portable computers within each company’s
23 market share:

24 ⁸⁹ See Kim Yoo-chul, *Samsung SDI to Supply Batteries to Dell, HP*, The Korea Times (Apr. 29,
25 2008, available at http://www.samsungsdi.com/f_news_view.sdi?post=E&seqno=1476 (last visited
June 30, 2013).

26 ⁹⁰ *Simplo Obtains Dell Orders for NB Battery*, Cens.com (Dec. 22, 2003),
27 http://cens.com/cens/html/en/news/news_inner_11540.html.

28 ⁹¹ *Simplo, Dynapack to See Auspicious Year in 2010*, Cens.com (Feb. 3, 2010),
http://cens.com/cens/html/en/news/news_inner_31131.html.

Laptop PC US Market Share Estimate, 2010

Company	Total PCs (IDC)	Est. Portable PCs	Value of Shipments	Share
HP	19,488,000	12,878,178	\$8,464,182,308	26.0%
Dell	17,352,000	11,466,653	\$7,536,457,892	23.1%
Acer	8,012,000	5,294,538	\$3,479,835,214	10.7%
Apple	6,571,000	4,342,288	\$2,853,968,696	8.8%
Toshiba	6,623,000	4,376,651	\$2,876,553,747	8.8%
Others	16,964,000	11,210,253	\$7,367,938,663	22.6%
Total	75,010,000	49,568,561	\$32,578,936,521	

2010 Portable PCs as Percent of US PC Sales	66.1%
2010 Average Notebook Price:	\$657.25

Notes:

Portable PCs estimated as 66.1% of total PC shipments as per IDC forecast.
Value of Shipments based on NPD's average notebook price for 2010.

Sources:

<http://blog.laptopmag.com/average-windows-laptop-costs-456-down-14-percent-in-24-months>
<http://www.idc.com/getdoc.jsp?containerId=prUS23261412>
<http://techcrunch.com/2010/06/15/idc-sees-pc-market-grow-by-19-8-in-2010/>

381. Massive amounts of portable computers, containing Defendants' Lithium Ion Batteries, have been sold each year in every state in the United States. According to the U.S. Census Bureau's Current Population Survey in October 2010 (released in July 2012), nearly 76% of the population (those individuals that are three (3) years and older) had access to the Internet from their household (which would itself require access to a computer, such as a laptop or tablet computer, or a smartphone). The following chart⁹² provides the numbers of households and percentage of population by state:

State	Total	Individual lives in household with Internet access	
		Number (in thousands)	Percent
United States	292,065	221,767	75.9
Alabama	4,503	3,016	67.0
Alaska	660	542	82.1

⁹² Table 3-A, available at *Computer and Internet Use in the United States: 2010*, United States Census Bureau, <http://www.census.gov/hhes/computer/publications/2010.html> (last visited June 30, 2013).

State	Total	Individual lives in household with Internet access	
		Number (in thousands)	Percent
Arizona	6,340	5,017	79.1
California	35,181	27,524	78.2
Colorado	4,836	3,769	77.9
Connecticut	3,364	2,792	83.0
Delaware	842	646	76.8
District of Columbia	581	446	76.9
Florida	17,688	13,552	76.6
Georgia	9,296	7,027	75.6
Hawaii	1,210	952	78.7
Idaho	1,468	1,174	80.0
Illinois	12,248	9,236	75.4
Indiana	6,139	4,101	66.8
Iowa	2,843	2,170	76.3
Kansas	2,649	2,156	81.4
Kentucky	4,067	2,727	67.0
Louisiana	4,272	2,940	68.8
Maine	1,254	1,005	80.2
Maryland	5,431	4,406	81.1
Massachusetts	6,389	5,331	83.4
Michigan	9,473	7,172	75.7
Minnesota	5,001	3,959	79.2
Mississippi	2,789	1,793	64.3
Missouri	5,625	4,161	74.0
Montana	920	688	74.8
Nebraska	1,695	1,304	76.9
Nevada	2,528	2,036	80.5
New Hampshire	1,270	1,094	86.2
New Jersey	8,269	6,661	80.6
New Mexico	1,899	1,218	64.1
New York	18,549	14,388	77.6
North Carolina	8,901	6,671	74.9
North Dakota	608	486	79.9
Ohio	11,000	7,969	72.4
Oklahoma	3,505	2,503	71.4
Oregon	3,695	3,005	81.3
Pennsylvania	11,981	9,296	77.6

State	Total	Individual lives in household with Internet access	
		Number (in thousands)	Percent
Rhode Island	994	781	78.6
South Carolina	4,310	2,906	67.4
South Dakota	763	561	73.6
Tennessee	6,068	4,209	69.4
Texas	23,481	16,802	71.6
Utah	2,681	2,293	85.5
Virginia	7,418	5,691	76.7
Vermont	592	468	79.1
Washington	6,373	5,328	83.6
West Virginia	1,753	1,264	72.1
Wisconsin	5,401	4,349	80.5
Wyoming	521	413	79.3
Source: U.S. Census Bureau, Current Population Survey, October 2010. Internet Release date: July 2012			

382. With respect to cell phones and smart phones, in 2011, CTIA, an international trade association that represents the wireless communications industry, reported that wireless device penetration in the U.S. was 102.2%, meaning the “# of active units divided by the total U.S. and territorial population (Puerto Rico, Guam and the U.S. Virgin Islands).”⁹³ It calculated the number of wireless devices in the United States to be approximately **316,000,000**. It defined wireless devices as including “smartphones, feature phones, tablets, hotspots, etc.”

383. Figure 15 is from an industry report and details the share of total purchases by many cell and smartphone OEMs from each supplier (*e.g.*, Defendants).

Figure 15: Cellular Phones/Lithium Ion Battery Supplier Relationships 2011

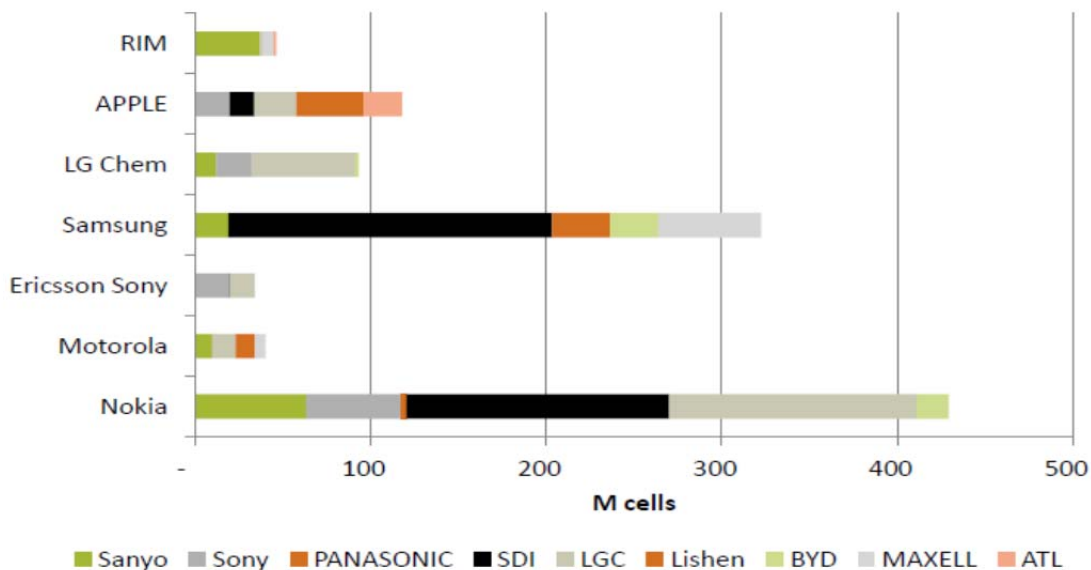

384. The following chart estimates the U.S. market shares of the leading cell and smart phone manufacturers:

Mobile Phone US Market Share Estimate, 2010

	Jan - Mar	Mar - May	July - Sep	Oct - Dec	Average Share
Samsung	21.9%	22.4%	23.5%	24.8%	23.2%
Mot	21.9%	21.2%	18.4%	16.7%	19.6%
LG	21.8%	21.5%	21.1%	20.9%	21.3%
RIM	8.3%	8.7%	9.3%	8.5%	8.7%
Nokia	8.3%	8.1%	7.4%	7.0%	7.7%
Other	17.8%	18.1%	20.3%	22.1%	19.6%

Total US Revenue \$10,700,000,000

Notes:

Shares are based on subscribers. Three month average for Apr - Jun was not available, so Mar - May average was used instead.

Sources:

- http://www.comscore.com/Insights/Press_Releases/2010/5/comScore_Reports_March_2010_U.S._Mobile_Subscriber_Market_Share
- http://www.comscore.com/Insights/Press_Releases/2010/7/comScore_Reports_May_2010_U.S._Mobile_Subscriber_Market_Share
- http://www.comscore.com/Insights/Press_Releases/2010/11/comScore_Reports_September_2010_U.S._Mobile_Subscriber_Market_Share
- http://www.comscore.com/Insights/Press_Releases/2011/2/comScore_Reports_December_2010_U.S._Mobile_Subscriber_Market_Share
- <http://www.reuters.com/article/2012/01/06/idUS33079+06-Jan-2012+BW20120106>

Smartphone Market US Market Share Estimate, 2010

	Market Share	Sales
HTC	19.0%	\$1,597,596,000
Motorola	11.0%	\$924,924,000
Samsung	7.0%	\$588,588,000
Apple	27.0%	\$2,270,268,000
RIM BlackBerry	27.0%	\$2,270,268,000
HP	1.0%	\$84,084,000
Nokia	2.0%	\$168,168,000
Other	6.0%	\$504,504,000
Total	100.0%	\$8,408,400,000

Estimate of Total Smartphone Units sold in U.S.: ¹	58.8 million
Estimate of Average Selling Price (ASP):	\$143
Estimate of Total U.S. Smartphone Market Value:	\$8,408,400,000

Notes:

¹Canalys reported that the U.S. smartphone market consisted of 14.7m units in Q2-2010. Yearly estimate is calculated by multiplying by 4.

Sources:

Market Share: Ziegler, Chris. "Visualized: US smartphone market share, by manufacturer and platform, made pretty."

Engadget. 3-Mar-11. Accessed 21-Jun-13. <http://www.engadget.com/2011/03/03/visualized-us-smartphone-market-share-by-manufacturer-and-plat/>.

Units Sold: "Android smart phone shipments grow 886% year-on-year in Q2 2010." Canalys. 2-Aug-2010. Accessed 21-Jun-13.

<http://www.canalys.com/newsroom/android-smart-phone-shipments-grow-886-year-year-q2-2010>.

ASP: Gonsalves, Antone. "Android Takes Lead In U.S. Smartphone Market." InformationWeek. 4-Aug-2010. Accessed 21-Jun-13.

<http://www.informationweek.com/software/operating-systems/android-takes-lead-in-us-smartphone-market/226500293>.

X. JURISDICTION AND VENUE

385. This Court has jurisdiction over the instant matter pursuant to 28 U.S.C. § 1332(d) and the Class Action Fairness Act of 2005 ("CAFA"), 28 U.S.C. § 1711, *et seq.*, which vest original jurisdiction in the district courts of the United States for any multi-state class action where the aggregate amount in controversy exceeds \$5 million and where the citizenship of any member of the class of plaintiffs is different from that of any defendant. The \$5 million amount-in-controversy and diverse citizenship requirements of CAFA are satisfied in this case.

386. Venue is appropriate in this district under 28 U.S.C. § 1391(b) and (c). During the Class Period many of the Defendants transacted business, were found, or had agents in this district and because a substantial portion of the affected interstate trade and commerce described below has been carried out in this district.

387. This Court has personal jurisdiction over each Defendant because, *inter alia*, each Defendant: (a) transacted business throughout the United States, including in this district; (b) participated in the sale and distribution of Lithium Ion Batteries throughout the United States, including in this district; (c) had substantial contacts with the United States, including in this district; and/or (d) was engaged in an illegal conspiracy that was directed at and had the intended effect of

1 causing injury to persons residing in, located in, or doing business throughout the United States,
2 including in this district.

3 388. Defendants engaged in conduct both inside and outside the U.S. that caused direct,
4 substantial and reasonably foreseeable and intended anti-competitive effects upon interstate
5 commerce within the United States.

6 389. The activities of the Defendants and their co-conspirators were within the flow of,
7 were intended to, and did have, a substantial effect on interstate commerce of the United States.
8 Defendants' products are sold in the flow of interstate commerce.

9 390. As described above in the previous section in more detail, Lithium Ion Batteries
10 manufactured abroad by Defendants and sold for use in Lithium Ion Battery Products either
11 manufactured in the United States or manufactured abroad and sold in the United States, are goods
12 brought into the United States for sale, and therefore constitute import commerce. To the extent any
13 Lithium Ion Batteries are not purchased in the U.S., and such Lithium Ion Batteries do not constitute
14 import commerce, Defendants' unlawful activities with respect thereto, as more fully alleged herein
15 during the Class period, had, and continue to have, a direct, substantial and reasonably foreseeable
16 effect on United States commerce. The anti-competitive conduct, and its effects on United States
17 commerce described herein, proximately caused antitrust injury to the Plaintiffs and members of the
18 Classes in the U.S.

19 391. By reason of the unlawful activities alleged herein, Defendants substantially affected
20 commerce throughout the U.S., causing injury to the Plaintiffs and members of the Classes.
21 Defendants, directly and through their agents, engaged in a conspiracy affecting all states to fix or
22 inflate prices of Lithium Ion Batteries, which unreasonably restrained trade and adversely affected
23 the market for Lithium Ion Batteries.

24 392. Defendants' conspiracy and wrongdoing described herein adversely affected persons
25 in the United States who purchased Lithium Ion Batteries or Lithium Ion Battery Products for
26 personal use and not for resale, including Plaintiffs and members of the Classes.

XI. PARTIES

A. Plaintiffs

393. Plaintiff Christopher Hunt is a resident of Phoenix, Arizona. During the Class Period, Plaintiff purchased a Sony GRZ 660 Laptop and a COMPAQ Presario CQ62Z Notebook, each containing a lithium-ion cylindrical battery cell manufactured by a Defendant. Plaintiff's purchases were made in Arizona and were made for Plaintiffs' own use and not for resale. As a result of the antitrust violations alleged in this complaint, the Plaintiff has suffered injury. Plaintiff Hunt is referred to herein as an "Arizona Plaintiff."

394. Plaintiff Piya Robert Rojanasathit is a resident of San Carlos, California. During the Class Period, Plaintiff purchased a Dell Studio 15 laptop, containing a lithium-ion cylindrical battery cell manufactured by a Defendant. Plaintiff's purchase was made in California and was made for Plaintiffs' own use and not for resale. As a result of the antitrust violations alleged in this complaint, the Plaintiff has suffered injury. Plaintiff Rojanasathit is referred to herein as a "California Plaintiff."

395. Plaintiff Steve Bugge is a resident of San Diego, California. During the Class Period, Plaintiff purchased a Toshiba laptop containing a lithium-ion cylindrical battery cell manufactured by a Defendant. Plaintiff's purchase was made in California and was made for Plaintiffs' own use and not for resale. As a result of the antitrust violations alleged in this complaint, the Plaintiff has suffered injury. Plaintiff Bugge is referred to herein as a "California Plaintiff."

396. Plaintiff Tom Pham is a resident of Aliso Viejo, California. During the Class Period, Plaintiff purchased a Dell laptop and a replacement battery for the laptop, each containing a lithium-ion cylindrical battery cell manufactured by a Defendant. Plaintiff's purchases were made in California and were made for Plaintiffs' own use and not for resale. As a result of the antitrust violations alleged in this complaint, the Plaintiff has suffered injury. Plaintiff Pham is referred to herein as a "California Plaintiff."

397. Plaintiff Bradley Seldin is a resident of Miami Beach, Florida. During the Class Period, Plaintiff purchased an Acer Aspire laptop containing a lithium-ion cylindrical battery cell manufactured by a Defendant. Plaintiff's purchase was made in Florida and was made for Plaintiffs'

1 own use and not for resale. As a result of the antitrust violations alleged in this complaint, the
2 Plaintiff has suffered injury. Plaintiff Seldin is referred to herein as a “Florida Plaintiff.”

3 398. Plaintiff Patrick McGuiness is a resident of Jacksonville, Florida. During the Class
4 Period, Plaintiff purchased a Dell Inspiron E105 laptop, a Sony Vaio laptop, a Sony camcorder, two
5 Black & Decker drills, a Black & Decker Pivot electric screwdriver, a Ryobi drill, and a DeWalt
6 Drill, all containing a lithium-ion cylindrical battery cell manufactured by a Defendant. Plaintiff’s
7 purchases were made in Florida and was made for Plaintiff’s own use and not for resale. As a result
8 of the antitrust violations alleged in this complaint, the Plaintiff has suffered injury. Plaintiff
9 McGuiness is referred to herein as a “Florida Plaintiff.”

10 399. Plaintiff John Kopp is a resident of Aurora, Illinois. During the Class Period, Plaintiff
11 purchased a Dell Notebook laptop computer containing a lithium-ion cylindrical battery cell
12 manufactured by a Defendant. Plaintiff’s purchase was made in Illinois and was made for Plaintiffs’
13 own use and not for resale. As a result of the antitrust violations alleged in this complaint, the
14 Plaintiff has suffered injury. Plaintiff Kopp is referred to herein as the “Illinois Plaintiff.”

15 400. Plaintiff Drew Fennelly is a resident of Lawrence, Kansas. During the Class Period,
16 Plaintiff purchased HP G62 Laptop, containing a lithium-ion cylindrical battery cell manufactured by
17 a Defendant as well as a replacement battery containing a lithium-ion cylindrical battery cell.
18 Plaintiff’s purchase was made in Kansas and was made for Plaintiffs’ own use and not for resale. As
19 a result of the antitrust violations alleged in this complaint, the Plaintiff has suffered injury. Plaintiff
20 Fennelly is referred to herein as the “Kansas Plaintiff.”

21 401. Plaintiff Jason Ames is a resident of Cape Elizabeth, Maine. During the Class Period,
22 Plaintiff purchased a Makita Cordless Drill and a Sony Mini DV Camcorder, containing a lithium-
23 ion cylindrical battery cell manufactured by a Defendant. Plaintiff’s purchases were made in Maine
24 and were made for Plaintiffs’ own use and not for resale. As a result of the antitrust violations
25 alleged in this complaint, the Plaintiff has suffered injury. Plaintiff Ames is referred to herein as the
26 “Maine Plaintiff.”

27 402. Plaintiff William Cabral is a resident of East Freetown, Massachusetts. During the
28 Class Period, Plaintiff purchased a Hewlett-Packard Pavillion laptop containing a lithium-ion

1 cylindrical battery cell manufactured by a Defendant. Plaintiff’s purchase was made in
2 Massachusetts and was made for Plaintiffs’ own use and not for resale. As a result of the antitrust
3 violations alleged in this complaint, the Plaintiff has suffered injury. Plaintiff Cabral is referred to
4 herein as a “Massachusetts Plaintiff.”

5 403. Plaintiff Donna Shawn is a resident of Rochester Hills, Michigan. During the Class
6 Period, Plaintiff purchased a Dell laptop containing a lithium-ion cylindrical battery cell
7 manufactured by a Defendant. Plaintiff’s purchase was made in Michigan and was made for
8 Plaintiffs’ own use and not for resale. As a result of the antitrust violations alleged in this complaint,
9 the Plaintiff has suffered injury. Plaintiff Shawn is referred to herein as a “Michigan Plaintiff.”

10 404. Plaintiff David Beson is a resident of Minnesota. During the Class Period, Plaintiff
11 purchased a Samsung laptop containing a lithium-ion cylindrical battery cell manufactured by a
12 Defendant. Plaintiff’s purchase was made in Minnesota and was made for Plaintiffs’ own use and not
13 for resale. As a result of the antitrust violations alleged in this complaint, the Plaintiff has suffered
14 injury. Plaintiff Beson is referred to herein as the “Minnesota Plaintiff.”

15 405. Plaintiff Maury “Kim” Billingsley is a resident of Booneville, Mississippi. During the
16 Class Period, Plaintiff purchased a Dell Inspiron 1420 laptop computer containing a lithium-ion
17 cylindrical battery cell manufactured by a Defendant. Plaintiff’s purchase was made in Mississippi
18 and was made for Plaintiffs’ own use and not for resale. As a result of the antitrust violations alleged
19 in this complaint, the Plaintiff has suffered injury. Plaintiff Billingsley is referred to herein as the
20 “Mississippi Plaintiff.”

21 406. Plaintiff Joseph O’Daniel is a resident of Lee’s Summit, Missouri. During the Class
22 Period, Plaintiff purchased a Hewlett-Packard laptop containing a lithium-ion cylindrical battery cell
23 manufactured by a Defendant. Plaintiff’s purchase was made in Missouri and was made for
24 Plaintiffs’ own use and not for resale. As a result of the antitrust violations alleged in this complaint,
25 the Plaintiff has suffered injury. Plaintiff O’Daniel is referred to herein as the “Missouri Plaintiff.”

26 407. Plaintiff Cindy Booze is a resident of Lincoln, Nebraska. During the Class Period,
27 Plaintiff purchased a Toshiba Satellite laptop containing a lithium-ion cylindrical battery cell
28 manufactured by a defendant. Plaintiff’s purchase was made in Nebraska and was made for

1 Plaintiffs’ own use and not for resale. As a result of the antitrust violations alleged in this complaint,
2 the Plaintiff has suffered injury. Plaintiff Booze is referred to herein as the “Nebraska Plaintiff.”

3 408. Plaintiff Matthew Ence is a resident of Minden, Nevada. During the Class Period,
4 Plaintiff purchased two Toshiba Satellite laptops, each containing a lithium-ion cylindrical battery
5 cell manufactured by a Defendant. Plaintiff’s purchases were made in Nevada and were made for
6 Plaintiffs’ own use and not for resale. As a result of the antitrust violations alleged in this complaint,
7 the Plaintiff has suffered injury. Plaintiff Ence is referred to herein as the “Nevada Plaintiff.”

8 409. Plaintiff David Tolchin is a resident of New York, New York. During the Class
9 Period, Plaintiff purchased a Dell Latitude D830 laptop and a Dell Inspiron 101 mini laptop,
10 containing a lithium-ion cylindrical battery cell manufactured by a Defendant. Plaintiff’s purchase
11 was made in New York and was made for Plaintiffs’ own use and not for resale. As a result of the
12 antitrust violations alleged in this complaint, the Plaintiff has suffered injury. Plaintiff Tolchin is
13 referred to herein as a “New York Plaintiff.”

14 410. Plaintiff Matt Bryant is a resident of West Henrietta, New York. During the Class
15 Period, Plaintiff purchased a Hewlett-Packard laptop containing a lithium-ion cylindrical battery cell
16 manufactured by a Defendant. Plaintiff’s purchase was made in New York and was made for
17 Plaintiffs’ own use and not for resale. As a result of the antitrust violations alleged in this complaint,
18 the Plaintiff has suffered injury. Plaintiff Bryant is referred to herein as a “New York Plaintiff.”

19 411. Plaintiff Sheri Harmon is a resident of Mulino, Oregon. During the Class Period,
20 Plaintiff purchased an HP laptop containing a lithium-ion cylindrical battery cell manufactured by a
21 Defendant. Plaintiff’s purchase was made in Oregon and was made for Plaintiffs’ own use and not
22 for resale. As a result of the antitrust violations alleged in this complaint, the Plaintiff has suffered
23 injury. Plaintiff Harmon is referred to herein as an “Oregon Plaintiff.”

24 412. Plaintiff Christopher Bessette is a resident of Rapid City, South Dakota. During the
25 Class Period, Plaintiff purchased a Toshiba laptop containing a lithium-ion cylindrical battery cell
26 manufactured by a Defendant. Plaintiff’s purchase was made in South Dakota and was made for
27 Plaintiffs’ own use and not for resale. As a result of the antitrust violations alleged in this complaint,
28

1 the Plaintiff has suffered injury. Plaintiff Bessette is referred to herein as the “South Dakota
2 Plaintiff.”

3 413. Plaintiff Caleb Batey is a resident of Tennessee. During the Class Period, Plaintiff
4 purchased two Asus laptops, a Toshiba laptop, and a Genesis laptop battery replacement, each
5 containing a lithium-ion cylindrical battery cell manufactured by the Defendant. Plaintiff’s purchases
6 were made in Tennessee and were made for Plaintiffs’ own use and not for resale. As a result of the
7 antitrust violations alleged in this complaint, the Plaintiff has suffered injury. Plaintiff Batey is
8 referred to herein as the “Tennessee Plaintiff.”

9 414. Plaintiff Linda Lincoln is a resident of Hurricane, West Virginia. During the Class
10 Period, Plaintiff purchased a Dell laptop containing a lithium-ion cylindrical battery cell
11 manufactured by a Defendant. Plaintiff’s purchase was made in West Virginia and was made for
12 Plaintiffs’ own use and not for resale. As a result of the antitrust violations alleged in this complaint,
13 the Plaintiff has suffered injury. Plaintiff Lincoln is referred to herein as the “West Virginia
14 Plaintiff.”

15 415. Plaintiff Bradley Van Patten is a resident of Wisconsin. During the Class Period,
16 Plaintiff purchased a Sony replacement battery for a laptop containing a lithium-ion cylindrical
17 battery cell manufactured by a Defendant. Plaintiff’s purchase was made in Wisconsin and was made
18 for Plaintiffs’ own use and not for resale. As a result of the antitrust violations alleged in this
19 complaint, the Plaintiff has suffered injury. Plaintiff Van Patten is referred to herein as the
20 “Wisconsin Plaintiff.”

21 **B. Governmental Plaintiffs**

22 416. Plaintiff City of Palo Alto (“Palo Alto”) is a political subdivision of the State of
23 California and a “Charter City” duly organized under Article XI, Section 3 of the California
24 Constitution. Incorporated in 1894, Palo Alto is situated in the heart of California’s “Silicon Valley”
25 and currently has a population of approximately 61,200 residents. During the Class Period, Palo Alto
26 purchased numerous products containing lithium-ion cylindrical battery cells manufactured by the
27 Defendants, as well as purchasing Lithium Ion Batteries themselves. These products include
28 camcorders and laptops containing batteries made by the Defendants. As a result of the misconduct

1 alleged herein, Palo Alto has suffered injury in that it paid more for those products than it would
2 have been charged in the absence of the misconduct.

3 417. Plaintiff City of Richmond (“Richmond”) is a political subdivision of the State of
4 California and a “Charter City” duly organized under Article XI, Section 3 of the California
5 Constitution. Incorporated in 1905, Richmond is the second largest city in Contra Costa County and
6 currently has a population of approximately 103,701 residents. During the relevant time period,
7 Richmond purchased numerous products containing lithium-ion cylindrical battery cells
8 manufactured by the Defendants, as well as purchasing Lithium Ion Batteries themselves. These
9 products include camcorders and laptops containing Lithium Ion Batteries made by the Defendants.
10 As a result of the misconduct alleged herein, Richmond has suffered injury in that it paid more for
11 those products than it would have been charged in the absence of the misconduct.

12 418. Plaintiffs City of Palo Alto and City of Richmond are referred to herein as the
13 “Governmental Plaintiffs.”

14 **C. Defendants**

15 419. Defendant LG Chem, Ltd. (“LG Chem”) is a Korean corporation with its principal
16 executive offices at 20 Yeouido-dong, Yeongdeungpo-gu, Seoul, South Korea. Defendant LG Chem
17 is an affiliate of Seoul-based conglomerate LG Electronics. LG Chem is one of the world’s leading
18 manufacturers of Lithium Ion Batteries. Defendant LG Chem, either directly or through a wholly
19 owned subsidiary, participated in the conspiracy alleged in this complaint and manufactured,
20 marketed and/or sold Lithium Ion Batteries that were purchased throughout the United States,
21 including in this district, during the Class Period.

22 420. Defendant LG Chem America, Inc. (“LGCAI”) is a New Jersey corporation with its
23 principal place of business at 1000 Sylvan Avenue, Englewood Cliffs, New Jersey 07632. Defendant
24 LGCAI is a wholly owned subsidiary of Defendant LG Chem, Ltd. Defendant LG Chem America,
25 either directly or through a wholly owned subsidiary, participated in the conspiracy alleged in this
26 complaint and manufactured, marketed and/or sold Lithium Ion Batteries that were purchased
27 throughout the United States, including in this district, during the Class Period.

1 421. Defendants LG Chem and LGCAI are collectively referred to herein as “LG” or “LG
2 Chem.”

3 422. Defendant Samsung SDI Co., Ltd. (“Samsung SDI”) is a Korean corporation with its
4 principal executive offices at 575 Shin-Dong, Youngtong-Gu, Suwon, Gyeonggi South Korea.
5 Defendant Samsung SDI Co., Ltd. is 20 percent owned by the Korean conglomerate Samsung
6 Electronics, Inc. Defendant Samsung SDI is the world’s largest manufacturer of Lithium Ion
7 Batteries. Defendant Samsung SDI, either directly or through a wholly owned subsidiary,
8 participated in the conspiracy alleged in this complaint and manufactured, marketed and/or sold
9 Lithium Ion Batteries that were distributed throughout the United States, including in this district,
10 during the Class Period.

11 423. Defendant Samsung SDI America, Inc. (“Samsung SDI America”) is a California
12 corporation with its principal executive offices at 85 W. Tasman Drive, San Jose, California 95134-
13 1703. Samsung SDI America is a wholly owned subsidiary of Defendant Samsung SDI. Defendant
14 Samsung SDI America, either directly or through a wholly owned subsidiary, participated in the
15 conspiracy alleged in this complaint and manufactured, marketed and/or sold Lithium Ion Batteries
16 that were distributed throughout the United States, including in this district, during the Class Period.

17 424. Defendants Samsung SDI and Samsung SDI America are collectively referred to
18 herein as “Samsung” or “SDI.”

19 425. Defendants LG and Samsung are referred to herein at times as the “Korean
20 Defendants,” to distinguish them from the remaining defendants, referred to herein at times as the
21 “Japanese Defendants.”

22 426. Defendant Panasonic Corporation is a Japanese corporation with its principal
23 executive offices at 1006 Oaza Kadoma, Osaka 571-8501, Japan. On or about October 1, 2008,
24 Panasonic Corporation issued a press release stating that “[e]ffective today, October 1, 2008,
25 Matsushita Electric Industrial Co., Ltd. has become Panasonic Corporation” and also that
26 “Matsushita Battery Industrial Co., Ltd., which used to be a wholly-owned subsidiary of Matsushita
27 Electric Industrial Co., Ltd., has become an internal divisional company of Panasonic
28

1 Corporation....”⁹⁴ Defendant Panasonic manufactures and sells Lithium Ion Batteries under the
2 Panasonic name and also under the name of Defendant and wholly owned subsidiary Sanyo Electric
3 Co., Ltd. With respect to those batteries sold under the Panasonic name, they are produced under
4 Panasonic’s internal division called “Energy Company.” Defendant Panasonic Corporation is one of
5 the world’s leading manufacturers of Lithium Ion Batteries. Defendant Panasonic Corporation, either
6 directly or through a wholly owned subsidiary, participated in the conspiracy alleged in this
7 complaint and manufactured, marketed and/or sold Lithium Ion Batteries that were distributed
8 throughout the United States, including in this district, during the Class Period.

9 427. Defendant Panasonic Corporation of North America, formerly known as Matsushita
10 Electric Corporation of America, is a Delaware Corporation with its principal executive offices at 1
11 Panasonic Way, Secaucus, New Jersey 07094. Panasonic Corporation of North America is a wholly
12 owned and controlled subsidiary of Defendant Panasonic Corporation. Defendant Panasonic
13 Corporation of North America, either directly or through a wholly owned subsidiary, participated in
14 the conspiracy alleged in this complaint and manufactured, marketed and/or sold Lithium Ion
15 Batteries that were distributed throughout the United States, including in this district, during the
16 Class Period.

17 428. Defendants Panasonic Corporation and Panasonic Corporation of North America are
18 collectively referred to herein as “Panasonic.”

19 429. Defendant Sanyo Electric Co., Ltd. (“Sanyo”) is a Japanese corporation with its
20 principal executive offices at 5-5 Keihan-Hondori, 2-chome, Moriguchi, Osaka 570-8677, Japan.
21 Defendant Sanyo is one of the largest manufacturers and suppliers of Lithium Ion Batteries in the
22 world. As of December 9, 2009, Defendant Sanyo became a wholly owned subsidiary of Defendant
23 Panasonic Corporation. Defendant Sanyo, directly or through a wholly owned subsidiary, including
24 through its joint venture Sanyo Soft Energy Co., Ltd., formed and operated with defendant GS-Yuasa
25 Corp., participated in the conspiracy alleged in this complaint and manufactured, marketed and/or
26

27 ⁹⁴ *Matsushita Electric Becomes Panasonic Corporation*, Panasonic (Oct. 1, 2008),
28 <http://panasonic.co.jp/corp/news/official.data/data.dir/en081001-4/en081001-4.html>.

1 sold Lithium Ion Batteries that were distributed throughout the United States, including in this
2 district, during the Class Period.

3 430. Defendant Sanyo North America Corporation is a Delaware corporation with its
4 principal executive offices at 2055 Sanyo Avenue, San Diego, California 92154. Defendant Sanyo
5 North America Corporation is a wholly owned subsidiary of Defendant Sanyo Electric Co., Ltd.
6 Defendant Sanyo North America Corporation, either directly or through a wholly owned subsidiary,
7 participated in the conspiracy alleged in this complaint and manufactured, marketed and/or sold
8 Lithium Ion Batteries that were distributed throughout the United States, including in this district,
9 during the Class Period.

10 431. Sanyo Electric Co., Ltd., Sanyo North America Corporation, and Sanyo GS Soft
11 Energy Co. Ltd. are collectively referred to herein as “Sanyo.”

12 432. Defendant Sony Corporation is a Japanese corporation with its principal executive
13 offices at 7-1 Konan 1-Chome, Minato-Ku, Tokyo, Japan. Defendant Sony Corporation invented the
14 Lithium Ion Battery in 1991 and since then, has been one of the world’s leading suppliers of Lithium
15 Ion Batteries. Defendant Sony Corporation, either directly or through a wholly owned subsidiary,
16 participated in the conspiracy alleged in this complaint and manufactured, marketed and/or sold
17 Lithium Ion Batteries that were distributed throughout the United States, including in this district,
18 during the Class Period.

19 433. Sony Energy Devices Corporation is a Japanese corporation with its principal
20 executive offices at 1-1 Shimosugishita, Takakura, Hiwada-machi, Koriyama-shi, Fukushima, Japan.
21 Defendant Sony Energy Devices Corporation is a wholly owned subsidiary of defendant Sony
22 Corporation. Sony Corporation manufactures its Lithium Ion Batteries through its Sony Energy
23 Devices Corporation subsidiary. Sony Energy Devices Corporation manufactures its Lithium Ion
24 Batteries at plants located in Japan, Singapore, and China. Defendant Sony Energy Devices
25 Corporation, either directly or through a wholly owned subsidiary, participated in the conspiracy
26 alleged in this complaint and manufactured, marketed and/or sold Lithium Ion Batteries that were
27 distributed throughout the United States, including in this district, during the Class Period.

1 434. Defendant Sony Electronics, Inc. is a Delaware corporation with its principal
2 executive offices at 16530 Via Esprillo, San Diego, CA 92127. Defendant Sony Electronics, Inc. is a
3 wholly owned subsidiary of defendant Sony Corporation. Defendant Sony Electronics, Inc., either
4 directly or through a wholly owned subsidiary, participated in the conspiracy alleged in this
5 complaint and manufactured, marketed and/or sold Lithium Ion Batteries that were distributed
6 throughout the United States, including in this district, during the Class Period.

7 435. Defendants Sony Corporation, Sony Energy Devices Corporation, and Sony
8 Electronics, Inc. are collectively referred to herein as “Sony.”

9 436. Defendant Hitachi Maxell, Ltd. (“Hitachi Maxell”) is a Japanese corporation with its
10 principal executive office at 2-18-2 Idabashi, Chiyoda-ku, Tokyo, 102-8521 Japan. Defendant
11 Hitachi Maxell is a wholly owned subsidiary of Hitachi, Ltd. Hitachi Maxell was founded in 1960
12 and manufactures and sells batteries through its batteries business unit. Defendant Hitachi Maxell,
13 either directly, or through a wholly owned subsidiary, participated in the conspiracy alleged in this
14 complaint and manufactured, marketed and/or sold Lithium Ion Batteries that were distributed
15 throughout the United States, including in this district, during the Class Period.

16 437. Defendant Maxell Corporation of America (“Maxell”) is a New Jersey corporation
17 with its principal executive office at 3 Garrett Mountain Plaza, 3rd Floor, Suite 300, Woodland Park,
18 New Jersey 07424. Defendant Maxell, either directly, or through a wholly owned subsidiary,
19 participated in the conspiracy alleged in this complaint and manufactured, marketed and/or sold
20 Lithium Ion Batteries that were distributed throughout the United States, including in this district,
21 during the Class Period.

22 438. Defendants Hitachi Maxell, Ltd., and Maxell Corporation of America are collectively
23 referred to herein as “Hitachi Maxell.”

24 439. Defendant NEC Corporation is a business entity organized under the laws of Japan,
25 with its principal place of business at 7-1, Shiba 5-chome, Minato-ku, Tokyo 108-8001, Japan.
26 Defendant NEC Corporation either directly, or through a wholly owned subsidiary, participated in
27 the conspiracy alleged in this complaint and manufactured, marketed and/or sold Lithium Ion
28

1 Batteries that were distributed throughout the United States, including in this district, during the
2 Class Period.

3 440. Defendant NEC Tokin Corporation is a Japanese corporation with its principal
4 executive office at 7-1, Kohriyama 6-chome, Taihaku-ku, Sendai-shi, Miyagi 982-8510, Japan.⁹⁵ Its
5 website presently states that the “Laminated lithium-ion rechargeable battery business was
6 transferred to ‘NEC Energy Devices, Ltd.,’ on April 1, 2010.”⁹⁶ The “NEC Technical Journal” in
7 2012 stated that “NEC Energy Device, Ltd. was established in 2010 for the development and
8 manufacture of lithium-ion batteries” and that “the precursor businesses and technological
9 developments have a history of over 20 years.”⁹⁷ The article continues that “NEC has been pursuing
10 battery business by focusing on compact batteries for mobile phones and digital still cameras for
11 consumer use” and that “[a]lthough the company names and management structures have changed a
12 great deal since the establishment of the joint venture Moli Energy Limited in 1990.”⁹⁸ Defendant
13 NEC Tokin Corporation, either directly, or through a wholly owned subsidiary, participated in the
14 conspiracy alleged in this complaint and manufactured, marketed and/or sold Lithium Ion Batteries
15 that were distributed throughout the United States, including in this district, during the Class Period.

16 441. Defendants NEC Corporation and NEC Tokin Corp. are referred to herein as “NEC.”

17 442. Defendant Toshiba Corporation (“Toshiba”) is a Japanese company with its principal
18 executive office at 1-1, Shibaura 1-chrome, Minato-ku, Tokyo 105-8001, Japan. Defendant Toshiba
19 Corporation, including through its subsidiaries A&T Battery Corporation and Toshiba America
20 Electronic Components Inc., either directly, or through a wholly owned subsidiary, participated in
21 the conspiracy alleged in this complaint and manufactured, marketed and/or sold Lithium Ion
22

23
24 ⁹⁵ *Corporate Outline*, NEC Tokin Corporation, <http://www.nec-tokin.com/english/info/gaiyo.html> (last visited June 10, 2013).

25 ⁹⁶ *Product Support*, NEC Tokin Corporation, <http://www.nec-tokin.com/english/contact/inquiry.php> (last visited June 10, 2013).

26 ⁹⁷ *Expanding Applications from Electric Vehicles to Energy Storage Systems - Unique*
27 *Technology Offering High Safety and High Power*, 7 NEC Technical Journal, 1, at 135 (2012),
available at www.nec.com/en/global/techrep/journal/g12/n01/pdf/120128.pdf.

28 ⁹⁸ *Id.*

1 Batteries that were distributed throughout the United States, including in this district, during the
2 Class Period.

3 443. Toshiba Corporation, and A&T Battery Corporation are collectively referred to as
4 “Toshiba.”

5 444. All of the foreign-based defendants identified above are at times referred to herein as
6 the “Foreign Defendants.”

7 445. All of the U.S.-based defendants identified above are at times referred to herein as the
8 “U.S. Subsidiary Defendants.”

9 **D. Agents and Co-Conspirators**

10 446. Defendants’ officers, directors, agents, employees, or representatives engaged in the
11 conduct alleged in this Complaint in the usual management, direction, or control of Defendants’
12 business or affairs.

13 447. Defendants are also liable for acts done in furtherance of the alleged conspiracy by
14 companies they acquired through mergers and acquisitions.

15 448. When Plaintiffs refer to a corporate family or companies by a single name in this
16 Complaint, they are alleging that one or more employees or agents of entities within that corporate
17 family engaged in conspiratorial acts on behalf of every company in that family. The individual
18 participants in the conspiratorial acts did not always know the corporate affiliation of their
19 counterparts, nor did they distinguish between the entities within a corporate family. The individual
20 participants entered into agreements on behalf of their respective corporate families. As a result,
21 those agents represented the entire corporate family with respect to such conduct, and the corporate
22 family was party to the agreements that those agents reached.

23 449. Each of the Defendants acted as the agent of, co-conspirator with, or joint venture
24 partner of the other Defendants and co-conspirators with respect to the acts, violations and common
25 course of conduct alleged in this Complaint. Each Defendant or co-conspirator that is a subsidiary of
26 a foreign parent acted as the United States agent for Lithium Ion Batteries and/or Lithium Ion Battery
27 Products made by its parent company.

1 All non-federal and non-state governmental entities in California that,
2 during the period from January 1, 2000 through May 31, 2011,
3 indirectly purchased new for their own use and not for resale one of the
4 following products which contained a lithium-ion cylindrical battery
5 manufactured by one or more defendants or their co-conspirators: (i) a
6 portable computer; (ii) a power tool; (iii) a camcorder; or (iv) a
7 replacement battery for any of these products. Excluded from the class
8 are any purchases of Panasonic-branded computers. Also excluded
9 from the class are any federal, state, or local governmental entities, any
10 judicial officers presiding over this action, members of their immediate
11 families and judicial staffs, and any juror assigned to this action

12 454. The Nationwide Damages Class, the State Damages Classes, and the California
13 Governmental Damages Subclass are collectively referred to herein as the “Classes” unless otherwise
14 indicated. Excluded from the Classes are Defendants, their parent companies, subsidiaries and
15 affiliates, Defendants’ attorneys in this matter, any co-conspirators, federal governmental entities and
16 instrumentalities of the federal government, states and their subdivisions, agencies and
17 instrumentalities, all judges assigned to this matter, all jurors in this matter, and all persons and
18 entities who only purchased Lithium Ion Battery Products directly or for resale.

19 455. While Plaintiffs do not know the exact number of the members of the Classes,
20 Plaintiffs believe there are at least hundreds of thousands of members in each Class.

21 456. Common questions of law and fact exist as to all members of the Classes. This is
22 particularly true given the nature of Defendants’ conspiracy, which was applicable to all of the
23 members of the Classes, thereby making appropriate relief with respect to the Classes as a whole.
24 Such questions of law and fact common to the Classes include, but are not limited to:

- 25 (a) Whether Defendants engaged in a combination and conspiracy among
26 themselves to fix, raise, maintain or stabilize the prices of Lithium Ion Batteries sold in the United
27 States;
- 28 (b) The identity of the participants of the alleged conspiracy;
- (c) The duration of the alleged conspiracy and the acts carried out by Defendants
in furtherance of the conspiracy;
- (d) Whether the alleged conspiracy violated the Sherman Act, as alleged in the
First Claim for Relief;

1 (e) Whether the alleged conspiracy violated California’s Cartwright Act, as
2 alleged in the Second Claim for Relief;

3 (f) Whether the alleged conspiracy violated California’s Unfair Competition Law,
4 as alleged in the Third Claim for Relief;

5 (g) Whether the alleged conspiracy violated various state antitrust and restraint of
6 trade laws, as alleged in the Fourth Claim for Relief;

7 (h) Whether the alleged conspiracy violated various state consumer protection and
8 unfair competition laws, as alleged in the Fifth Claim for Relief;

9 (i) Whether the conduct of Defendants, as alleged in this Complaint, caused
10 injury to the business or property of Plaintiffs and the members of the Classes;

11 (j) The effect of the alleged conspiracy on the prices of Lithium Ion Batteries and
12 Lithium Ion Battery Products sold in the United States during the Class Period;

13 (k) The appropriate injunctive and related equitable relief for the Injunctive Class;

14 (l) The appropriate class-wide measure of damages for the Nationwide Damages
15 Class; and

16 (m) The appropriate class-wide measure of damages for the State Damages
17 Classes.

18 457. Plaintiffs’ claims are typical of the claims of the members of the Classes, and
19 Plaintiffs will fairly and adequately protect the interests of the Classes. Plaintiffs and all members of
20 the Classes are similarly affected by Defendants’ wrongful conduct in that they paid artificially
21 inflated prices for Lithium Ion Batteries or Lithium Ion Battery Products purchased indirectly from
22 Defendants.

23 458. Plaintiffs’ claims arise out of the same common course of conduct giving rise to the
24 claims of the other members of the Classes. Plaintiffs’ interests are coincident with, and not
25 antagonistic to, those of the other members of the Classes. Plaintiffs are represented by counsel who
26 are competent and experienced in the prosecution of antitrust, consumer protection and class action
27 litigation.

28

1 459. The questions of law and fact common to the members of the Classes predominate
2 over any questions affecting only individual members, including legal and factual issues relating to
3 liability and damages.

4 460. Class action treatment is a superior method for the fair and efficient adjudication of
5 the controversy, in that, among other things, such treatment will permit a large number of similarly
6 situated persons to prosecute their common claims in a single forum simultaneously, efficiently and
7 without the unnecessary duplication of evidence, effort and expense that numerous individual actions
8 would engender. The benefits of proceeding through the class mechanism, including providing
9 injured persons or entities with a method for obtaining redress for claims that it might not be
10 practicable to pursue individually, substantially outweigh any difficulties that may arise in
11 management of this class action.

12 461. The prosecution of separate actions by individual members of the Classes would
13 create a risk of inconsistent or varying adjudications, establishing incompatible standards of conduct
14 for Defendants.

15 462. Plaintiffs bring the State Damages Classes on behalf of all persons similarly situated
16 pursuant to Rule 23 of the Federal Rules of Civil Procedure, on behalf of all members of the
17 following classes (and, as stated above, assert a “California Governmental Damages Subclass” as a
18 part of each class):

- 19 (a) **Arizona Damages Class**: All persons and entities who, as residents of
20 Arizona and during the period from January 1, 2000 through May 31, 2011,
21 indirectly purchased new for their own use and not for resale one of the
22 following products which contained a lithium-ion cylindrical battery
23 manufactured by one or more defendants or their co-conspirators: (i) a
24 portable computer; (ii) a power tool; (iii) a camcorder; or (iv) a replacement
25 battery for any of these products. Excluded from the class are any purchases
26 of Panasonic-branded computers. Also excluded from the class are any
27 federal, state, or local governmental entities, any judicial officers presiding
28 over this action, members of their immediate families and judicial staffs, and
any juror assigned to this action.
- (b) **California Damages Class**: All persons and entities who, as residents of
California and during the period from January 1, 2000 through May 31, 2011,
indirectly purchased new for their own use and not for resale one of the
following products which contained a lithium-ion cylindrical battery

1 manufactured by one or more defendants or their co-conspirators: (i) a
 2 portable computer; (ii) a power tool; (iii) a camcorder; or (iv) a replacement
 3 battery for any of these products. Excluded from the class are any purchases
 4 of Panasonic-branded computers. Also excluded from the class are any
 5 federal, state, or local governmental entities, any judicial officers presiding
 6 over this action, members of their immediate families and judicial staffs, and
 7 any juror assigned to this action.

8 (c) **Florida Damages Class**: All persons and entities who, as residents of Florida
 9 and during the period from January 1, 2000 through May 31, 2011, indirectly
 10 purchased new for their own use and not for resale one of the following
 11 products which contained a lithium-ion cylindrical battery manufactured by
 12 one or more defendants or their co-conspirators: (i) a portable computer; (ii) a
 13 power tool; (iii) a camcorder; or (iv) a replacement battery for any of these
 14 products. Excluded from the class are any purchases of Panasonic-branded
 15 computers. Also excluded from the class are any federal, state, or local
 16 governmental entities, any judicial officers presiding over this action,
 17 members of their immediate families and judicial staffs, and any juror
 18 assigned to this action.

19 (d) **Illinois Damages Class**: All persons and entities who, as residents of Illinois
 20 and during the period from January 1, 2000 through May 31, 2011, indirectly
 21 purchased new for their own use and not for resale one of the following
 22 products which contained a lithium-ion cylindrical battery manufactured by
 23 one or more defendants or their co-conspirators: (i) a portable computer; (ii) a
 24 power tool; (iii) a camcorder; or (iv) a replacement battery for any of these
 25 products. Excluded from the class are any purchases of Panasonic-branded
 26 computers. Also excluded from the class are any federal, state, or local
 27 governmental entities, any judicial officers presiding over this action,
 28 members of their immediate families and judicial staffs, and any juror
 assigned to this action.

(e) **Kansas Damages Class**: All persons and entities who, as residents of Kansas
 and during the period from January 1, 2000 through May 31, 2011, indirectly
 purchased new for their own use and not for resale one of the following
 products which contained a lithium-ion cylindrical battery manufactured by
 one or more defendants or their co-conspirators: (i) a portable computer; (ii) a
 power tool; (iii) a camcorder; or (iv) a replacement battery for any of these
 products. Excluded from the class are any purchases of Panasonic-branded
 computers. Also excluded from the class are any federal, state, or local
 governmental entities, any judicial officers presiding over this action,
 members of their immediate families and judicial staffs, and any juror
 assigned to this action.

(f) **Maine Damages Class**: All persons and entities who, as residents of Maine
 and during the period from January 1, 2000 through May 31, 2011, indirectly
 purchased new for their own use and not for resale one of the following
 products which contained a lithium-ion cylindrical battery manufactured by

1 one or more defendants or their co-conspirators: (i) a portable computer; (ii) a
2 power tool; (iii) a camcorder; or (iv) a replacement battery for any of these
3 products. Excluded from the class are any purchases of Panasonic-branded
4 computers. Also excluded from the class are any federal, state, or local
5 governmental entities, any judicial officers presiding over this action,
6 members of their immediate families and judicial staffs, and any juror
7 assigned to this action.

8 (g) **Massachusetts Damages Class**: All persons and entities who, as residents of
9 Massachusetts and during the period from January 1, 2000 through May 31,
10 2011, indirectly purchased new for their own use and not for resale one of the
11 following products which contained a lithium-ion cylindrical battery
12 manufactured by one or more defendants or their co-conspirators: (i) a
13 portable computer; (ii) a power tool; (iii) a camcorder; or (iv) a replacement
14 battery for any of these products. Excluded from the class are any purchases
15 of Panasonic-branded computers. Also excluded from the class are any
16 federal, state, or local governmental entities, any judicial officers presiding
17 over this action, members of their immediate families and judicial staffs, and
18 any juror assigned to this action.

19 (h) **Michigan Damages Class**: All persons and entities who, as residents of
20 Michigan and during the period from January 1, 2000 through May 31, 2011,
21 indirectly purchased new for their own use and not for resale one of the
22 following products which contained a lithium-ion cylindrical battery
23 manufactured by one or more defendants or their co-conspirators: (i) a
24 portable computer; (ii) a power tool; (iii) a camcorder; or (iv) a replacement
25 battery for any of these products. Excluded from the class are any purchases
26 of Panasonic-branded computers. Also excluded from the class are any
27 federal, state, or local governmental entities, any judicial officers presiding
28 over this action, members of their immediate families and judicial staffs, and
any juror assigned to this action.

(i) **Minnesota Damages Class**: All persons and entities who, as residents of
Minnesota and during the period from January 1, 2000 through May 31, 2011,
indirectly purchased new for their own use and not for resale one of the
following products which contained a lithium-ion cylindrical battery
manufactured by one or more defendants or their co-conspirators: (i) a
portable computer; (ii) a power tool; (iii) a camcorder; or (iv) a replacement
battery for any of these products. Excluded from the class are any purchases
of Panasonic-branded computers. Also excluded from the class are any
federal, state, or local governmental entities, any judicial officers presiding
over this action, members of their immediate families and judicial staffs, and
any juror assigned to this action.

(j) **Mississippi Damages Class**: All persons and entities who, as residents of
Mississippi and during the period from January 1, 2000 through May 31,
2011, indirectly purchased new for their own use and not for resale one of the
following products which contained a lithium-ion cylindrical battery

1 manufactured by one or more defendants or their co-conspirators: (i) a
2 portable computer; (ii) a power tool; (iii) a camcorder; or (iv) a replacement
3 battery for any of these products. Excluded from the class are any purchases
4 of Panasonic-branded computers. Also excluded from the class are any
5 federal, state, or local governmental entities, any judicial officers presiding
6 over this action, members of their immediate families and judicial staffs, and
7 any juror assigned to this action.

8 (k) **Missouri Damages Class**: All persons and entities who, as residents of
9 Missouri and during the period from January 1, 2000 through May 31, 2011,
10 indirectly purchased new for their own use and not for resale one of the
11 following products which contained a lithium-ion cylindrical battery
12 manufactured by one or more defendants or their co-conspirators: (i) a
13 portable computer; (ii) a power tool; (iii) a camcorder; or (iv) a replacement
14 battery for any of these products. Excluded from the class are any purchases
15 of Panasonic-branded computers. Also excluded from the class are any
16 federal, state, or local governmental entities, any judicial officers presiding
17 over this action, members of their immediate families and judicial staffs, and
18 any juror assigned to this action.

19 (l) **Nebraska Damages Class**: All persons and entities who, as residents of
20 Nebraska and during the period from January 1, 2000 through May 31, 2011,
21 indirectly purchased new for their own use and not for resale one of the
22 following products which contained a lithium-ion cylindrical battery
23 manufactured by one or more defendants or their co-conspirators: (i) a
24 portable computer; (ii) a power tool; (iii) a camcorder; or (iv) a replacement
25 battery for any of these products. Excluded from the class are any purchases
26 of Panasonic-branded computers. Also excluded from the class are any
27 federal, state, or local governmental entities, any judicial officers presiding
28 over this action, members of their immediate families and judicial staffs, and
any juror assigned to this action.

(m) **Nevada Damages Class**: All persons and entities who, as residents of Nevada
and during the period from January 1, 2000 through May 31, 2011, indirectly
purchased new for their own use and not for resale one of the following
products which contained a lithium-ion cylindrical battery manufactured by
one or more defendants or their co-conspirators: (i) a portable computer; (ii) a
power tool; (iii) a camcorder; or (iv) a replacement battery for any of these
products. Excluded from the class are any purchases of Panasonic-branded
computers. Also excluded from the class are any federal, state, or local
governmental entities, any judicial officers presiding over this action,
members of their immediate families and judicial staffs, and any juror
assigned to this action.

(n) **New York Damages Class**: All persons and entities who, as residents of New
York and during the period from January 1, 2000 through May 31, 2011,
indirectly purchased new for their own use and not for resale one of the
following products which contained a lithium-ion cylindrical battery

1 manufactured by one or more defendants or their co-conspirators: (i) a
 2 portable computer; (ii) a power tool; (iii) a camcorder; or (iv) a replacement
 3 battery for any of these products. Excluded from the class are any purchases
 4 of Panasonic-branded computers. Also excluded from the class are any
 5 federal, state, or local governmental entities, any judicial officers presiding
 6 over this action, members of their immediate families and judicial staffs, and
 7 any juror assigned to this action.

8 (o) **Oregon Damages Class**: All persons and entities who, as residents of Oregon
 9 and during the period from January 1, 2000 through May 31, 2011, indirectly
 10 purchased new for their own use and not for resale one of the following
 11 products which contained a lithium-ion cylindrical battery manufactured by
 12 one or more defendants or their co-conspirators: (i) a portable computer; (ii) a
 13 power tool; (iii) a camcorder; or (iv) a replacement battery for any of these
 14 products. Excluded from the class are any purchases of Panasonic-branded
 15 computers. Also excluded from the class are any federal, state, or local
 16 governmental entities, any judicial officers presiding over this action,
 17 members of their immediate families and judicial staffs, and any juror
 18 assigned to this action.

19 (p) **South Dakota Damages Class**: All persons and entities who, as residents of
 20 South Dakota and during the period from January 1, 2000 through May 31,
 21 2011, indirectly purchased new for their own use and not for resale one of the
 22 following products which contained a lithium-ion cylindrical battery
 23 manufactured by one or more defendants or their co-conspirators: (i) a
 24 portable computer; (ii) a power tool; (iii) a camcorder; or (iv) a replacement
 25 battery for any of these products. Excluded from the class are any purchases
 26 of Panasonic-branded computers. Also excluded from the class are any
 27 federal, state, or local governmental entities, any judicial officers presiding
 28 over this action, members of their immediate families and judicial staffs, and
 any juror assigned to this action.

(q) **Tennessee Damages Class**: All persons and entities who, as residents of
 Tennessee and during the period from January 1, 2000 through May 31, 2011,
 indirectly purchased new for their own use and not for resale one of the
 following products which contained a lithium-ion cylindrical battery
 manufactured by one or more defendants or their co-conspirators: (i) a
 portable computer; (ii) a power tool; (iii) a camcorder; or (iv) a replacement
 battery for any of these products. Excluded from the class are any purchases
 of Panasonic-branded computers. Also excluded from the class are any
 federal, state, or local governmental entities, any judicial officers presiding
 over this action, members of their immediate families and judicial staffs, and
 any juror assigned to this action.

(r) **West Virginia Damages Class**: All persons and entities who, as residents of
 West Virginia and during the period from January 1, 2000 through May 31,
 2011, indirectly purchased new for their own use and not for resale one of the
 following products which contained a lithium-ion cylindrical battery

1 manufactured by one or more defendants or their co-conspirators: (i) a
2 portable computer; (ii) a power tool; (iii) a camcorder; or (iv) a replacement
3 battery for any of these products. Excluded from the class are any purchases
4 of Panasonic-branded computers. Also excluded from the class are any
5 federal, state, or local governmental entities, any judicial officers presiding
6 over this action, members of their immediate families and judicial staffs, and
7 any juror assigned to this action.

- 8 (s) **Wisconsin Damages Class:** All persons and entities who, as residents of
9 Wisconsin and during the period from January 1, 2000 through May 31, 2011,
10 indirectly purchased new for their own use and not for resale one of the
11 following products which contained a lithium-ion cylindrical battery
12 manufactured by one or more defendants or their co-conspirators: (i) a
13 portable computer; (ii) a power tool; (iii) a camcorder; or (iv) a replacement
14 battery for any of these products. Excluded from the class are any purchases
15 of Panasonic-branded computers. Also excluded from the class are any
16 federal, state, or local governmental entities, any judicial officers presiding
17 over this action, members of their immediate families and judicial staffs, and
18 any juror assigned to this action.

19 XIII. VIOLATIONS ALLEGED

20 FIRST CLAIM FOR RELIEF 21 (VIOLATIONS OF SHERMAN ACT, 15 U.S.C. § 1) 22 (On Behalf of All Plaintiffs against All Defendants)

23 463. Plaintiffs incorporate and reallege, as though fully set forth herein, each of the
24 paragraphs set forth above.

25 464. Defendants and unnamed coconspirators entered into and engaged in a contract,
26 combination, or conspiracy in unreasonable restraint of trade in violation of Section One of the
27 Sherman Act (15 U.S.C. § 1).

28 465. Beginning as early as 2000 and continuing through May 31, 2011, the exact starting
date being unknown to Plaintiffs and exclusively within the knowledge of Defendants, Defendants
and their co-conspirators entered into a continuing contract, combination or conspiracy to
unreasonably restrain trade and commerce in violation of Section 1 of the Sherman Act (15 U.S.C.
§ 1) by artificially reducing or eliminating competition in the United States.

466. In particular, Defendants have combined and conspired to raise, fix, maintain or
stabilize the prices of Lithium Ion Batteries.

1 467. As a result of Defendants' unlawful conduct, prices for Lithium Ion Batteries were
2 raised, fixed, maintained, and stabilized in the United States.

3 468. The contract, combination or conspiracy among Defendants consisted of a continuing
4 agreement, understanding, and concerted action among Defendants and their co-conspirators.

5 469. For purposes of formulating and effectuating their contract, combination, or
6 conspiracy, Defendants and their co-conspirators did those things they contracted, combined, or
7 conspired to do, including:

- 8 (a) exchanged information on prices charged for Lithium Ion Batteries;
9 (b) agreed to raise, fix, and maintain prices for Lithium Ion Batteries;
10 (c) raised, fixed, and maintained prices for Lithium Ion Batteries; and
11 (d) sold Lithium Ion Batteries into and throughout the U.S. at non-competitive
12 prices.

13 470. As a result of Defendants' unlawful conduct, Plaintiffs and the other members of the
14 Class have been injured in their businesses and property in that they have paid more for Lithium Ion
15 Batteries and Lithium Ion Battery Products than they otherwise would have paid in the absence of
16 Defendants' unlawful conduct.

17 471. The alleged contract, combination or conspiracy is a per se violation of the federal
18 antitrust laws.

19 472. These violations are continuing and will continue unless enjoined by this Court.

20 473. Pursuant to Section 16 of the Clayton Act, 15 U.S.C. § 26, Plaintiffs and the Class
21 seek the issuance of an injunction against Defendants, preventing and restraining the violations
22 alleged herein.

23 **SECOND CLAIM FOR RELIEF**

24 **VIOLATIONS OF THE CARTWRIGHT ACT,**
25 **CAL. BUS. & PROF. CODE §§ 16720, et seq.)**
26 **(On Behalf of All Plaintiffs against All Defendants)**

27 474. Plaintiffs incorporate by reference all the above allegations as if fully set forth herein.
28

1 475. By reason of the foregoing, Defendants have violated California Business and
2 Professions Code, §§ 16700, *et seq.* California Plaintiff on behalf of a nationwide class of Indirect
3 Purchasers alleges as follows.

4 476. Beginning at a time currently unknown to California Plaintiff, but at least as early as
5 January 1, 2000, and continuing thereafter through May 31, 2011, Defendants and their co-
6 conspirators entered into and engaged in a continuing unlawful trust in restraint of the trade and
7 commerce described above in violation of section 16720, California Business and Professions Code.
8 Defendants, and each of them, have acted in violation of section 16720 to fix, raise, stabilize, and
9 maintain prices of, and allocate markets for Lithium Ion Batteries at supra-competitive levels.

10 477. In particular, Defendants have combined and conspired to raise, fix, maintain or
11 stabilize the prices of Lithium Ion Batteries sold in the United States.

12 478. As a result of Defendants' unlawful conduct, prices for Lithium Ion Batteries were
13 raised, fixed, maintained, and stabilized in the United States.

14 479. The contract, combination or conspiracy among Defendants consisted of a continuing
15 agreement, understanding, and concerted action among Defendants and their co-conspirators.

16 480. For purposes of formulating and effectuating their contract, combination, or
17 conspiracy, Defendants and their co-conspirators did those things they contracted, combined, or
18 conspired to do, including:

19 a. Participating in meetings and conversations to discuss the prices and supply of
20 Lithium Ion Batteries.

21 b. Communicating in writing and orally to fix prices of Lithium Ion Batteries.

22 c. Agreeing to manipulate prices and supply of Lithium Ion Batteries sold in the
23 United States in a manner that deprived direct and indirect purchasers of free and open competition.

24 d. Issuing price announcements and price quotations in accordance with the
25 agreements reached.

26 e. Selling Lithium Ion Batteries to customers in the United States at non-
27 competitive prices.

1 f. Providing false statements to the public to explain increased prices for Lithium
2 Ion Batteries.

3 481. As a direct and proximate result of Defendants' unlawful conduct, California
4 plaintiffs and the members of the California Indirect Purchaser Class have been injured in their
5 business and property in that they paid more for Lithium Ion Batteries and Lithium Ion Battery
6 Products than they otherwise would have paid in the absence of Defendants' unlawful conduct. As a
7 result of Defendants' violation of Section 16720 of the California Business and Professions Code,
8 California Plaintiff and the California Indirect Purchaser Class seek treble damages and their cost of
9 suit, including a reasonable attorney's fee, pursuant to section 16750(a) of the California Business
10 and Professions Code.

11 482. It is appropriate to apply California antitrust law to purchasers of Lithium Ion
12 Batteries and Lithium Ion Battery Products in all fifty states – that is, nationwide. Nationwide
13 application of California law is proper because three of six U.S.-based defendants (Sony Electronics,
14 Inc., Samsung SDI America, Inc., and Sanyo North America Corp.), are headquartered in California,
15 conspiratorial acts occurred in California, and the conspirators targeted their price-fixing activities at
16 large purchasers of Lithium Ion Batteries and Lithium Ion Battery Products in California, such as HP
17 and Apple.

18 483. Seven of the nine Defendant groups – LG, Panasonic, Sanyo, Sony, Samsung, Hitachi
19 Maxell, and Toshiba – maintained sales and marketing arms in the United States to conduct business
20 with major customers.⁹⁹ These Defendants are incorporated, located, and headquartered in the United
21 States, and each does substantial business in domestic interstate commerce throughout the United
22 States. For example, Defendant Samsung SDI America, Inc. maintained sales and marketing
23 personnel in Los Angeles, Chicago, Austin, and Houston to be responsible for Dell, Apple, Lab126,
24 Garmin, Palm, Black & Decker, Hewlett-Packard, Motorola, and other accounts. Those United
25 States-based personnel reported to Y.A. Oh, who served simultaneously as the President of Samsung
26 SDI America, Inc. and as the Vice President for North America of Samsung SDI Co., Ltd. Sanyo

27 ⁹⁹ The remaining Defendant groups also have United States-based subsidiaries that do
28 substantial business in domestic interstate commerce throughout the United States.

1 similarly stationed sales and engineering personnel in Texas to support the Hewlett-Packard and Dell
2 accounts, and in Chicago to support the Motorola and Black & Decker accounts. Sony also
3 responded to its United States customers' demands for lower prices by dispatching business and
4 engineering personnel to its offices in the United States.

5 484. Furthermore, LG produced documents directly implicating the San Jose, California
6 office of LG Chem in price-fixing.

7 485. In late 2010, Samsung and LG, including directly through LG's San Jose, California
8 office, in furtherance of Defendants' conspiracy, expressly agreed on price levels to be charged for
9 sales to Apple computer relating to Apple's iPad. Specifically, on December 1, 2010, at 5:03 PM,
10 LG Chem America, Inc.'s Dong Woo Lee, a/k/a "Don Lee" or "Donny," emailed several LG
11 executives from his San Jose, California office located at 2450 N. First St. #400. He wrote to Young
12 Wook Chung a/k/a (Andrew (Y.O.) Chung) and four others that, regarding "K93 related information
13 – D Company Meeting," that "I update the mutually shared K93-related information [meaning iPad
14 information] at the meeting with D Company [meaning Samsung SDI America] today. 1. Price: \$
15 0.42~43/Wh range. We said that our price is a little bit higher than \$0.38, and ***told them not to cut
16 the price since we currently plan to increase the price to \$0.42 level.***"

17 486. LG's Yong Wook Chung wrote back that same night to Dong Woo Lee in San Jose, at
18 12:37 a.m., copying also LG's Young Sun Kim, Sung Jun Cho, Jung Ho Yoo and Hyunhwa Kim,
19 stating "It's good information. Please send me the feedback after identifying if they [Samsung] can
20 move in the same price range." LG's Young Wook Chung further wrote that same day, "***We plan to
21 go ahead with at least \$0.50, and the counterpart's [meaning Samsung] vice president Oh, Yo Ahn
22 agreed on this, so please try to create the same kind of feeling with the counterpart, and never
23 make a sound in doing so.***"

24 487. LG's Mr. Chung wrote again that same day to Dong Woo Lee in San Jose, stating that
25 "We said that we would raise the price at least by 10% from the existing price, and they [Samsung]
26 also promised to commit."

27 488. The eleven foreign-based corporations have no reasonable expectation as to the
28 application of different state laws. Indeed, Defendants even entered into contracts specifying that

1 California law would govern disputes. For example, Samsung produced an amendment to a “Master
2 Goods Agreement” that it entered into with Apple Inc. appearing to indicate that “California law”
3 would govern any disputes between them.

4 489. If the Court were to determine that California law should not apply nationwide, If the
5 Court declines to certify the above nationwide class under California, IPPs propose certification of a
6 class, under California law, of the following nineteen states: Arizona, California, Florida, Illinois,
7 Kansas, Maine, Massachusetts, Michigan, Minnesota, Mississippi, Missouri, Nebraska, Nevada, New
8 York, Oregon, South Dakota, Tennessee, West Virginia, and Wisconsin. This is because the law of
9 these thirty states is harmonized so there is no true conflict of law here.

10 **THIRD CLAIM FOR RELIEF**

11 **VIOLATIONS OF CALIFORNIA’S UNFAIR COMPETITION LAW**
12 **CAL. BUS. & PROF. CODE §§ 17200, *et seq.***
(On Behalf of All Plaintiffs against All Defendants)

13 490. Plaintiffs incorporate by reference the allegations in the above paragraphs as if fully
14 set forth herein.

15 491. By reason of the foregoing, Defendants have violated California’s Unfair Competition
16 Law, Cal. Bus. & Prof. Code §§ 17200, *et seq.*

17 492. Defendants committed acts of unfair competition, as defined by section 17200, *et seq.*,
18 by engaging in a conspiracy to fix and stabilize the price of Lithium Ion Batteries as described above.

19 493. The acts, omissions, misrepresentations, practices and non-disclosures of Defendants,
20 as described above, constitute a common and continuing course of conduct of unfair competition by
21 means of unfair, unlawful and/or fraudulent business acts or practices with the meaning of Section
22 17200, *et seq.*, including, but not limited to (1) violations of Section 1 of the Sherman Act; and (2)
23 violations of the Cartwright Act.

24 494. Defendants’ acts, omissions, misrepresentations, practices and nondisclosures are
25 unfair, unconscionable, unlawful and/or fraudulent independently of whether they constitute a
26 violation of the Sherman Act or the Cartwright Act.

27 495. Defendants’ acts or practices are fraudulent or deceptive within the meaning of
28 section 17200, *et seq.*

1 c. As a direct and proximate result of Defendants' unlawful conduct, Arizona
2 Plaintiff and members of the Arizona Damages Class have been injured in their business and
3 property and are threatened with further injury.

4 d. By reason of the foregoing, Defendants entered into agreements in restraint of
5 trade in violation of Arizona Revised Statutes §§ 44-1401, *et seq.* Accordingly, Arizona Plaintiff and
6 the members of the Arizona Damages Class seek all forms of relief available under Arizona Revised
7 Statutes §§ 44-1401, *et seq.*

8 501. California: By reason of the foregoing, Defendants have violated California Business
9 and Professions Code, § 16700, *et seq.* California Plaintiff on behalf of the California Damages
10 Class alleges as follows:

11 a. Defendants' contract, combination, trust or conspiracy was entered in, carried
12 out, effectuated and perfected mainly within the State of California, and Defendants' conduct within
13 California injured all members of the class throughout the United States. Therefore, this claim for
14 relief under California law is brought on behalf of the California Damages Class.

15 b. Beginning at a time currently unknown to California Plaintiff, but at least as
16 early as January 1, 2000, and continuing thereafter at least up to May 31, 2011, Defendants and their
17 co-conspirators entered into and engaged in a continuing unlawful trust in restraint of the trade and
18 commerce described above in violation of section 16720, California Business and Professions Code.
19 Defendants, and each of them, have acted in violation of section 16720 to fix, raise, stabilize, and
20 maintain prices of Lithium Ion Batteries at supra-competitive levels.

21 c. The aforesaid violations of section 16720, California Business and Professions
22 Code, consisted, without limitation, of a continuing unlawful trust and concert of action among the
23 defendants and their co-conspirators, the substantial terms of which were to fix, raise, maintain, and
24 stabilize the prices of Lithium Ion Batteries.

25 d. For the purpose of forming and effectuating the unlawful trust, the Defendants
26 and their co-conspirators have done those things which they combined and conspired to do, including
27 but not in any way limited to the acts, practices and course of conduct set forth above and fixing,
28 raising, stabilizing, and pegging the price of Lithium Ion Batteries.

1 e. The combination and conspiracy alleged herein has had, *inter alia*, the
2 following effects: (1) price competition in the sale of Lithium Ion Batteries has been restrained,
3 suppressed, and/or eliminated in the State of California; (2) prices for Lithium Ion Batteries have
4 been fixed, raised, stabilized, and pegged at artificially high, noncompetitive levels in the State of
5 California; and (3) those who purchased Lithium Ion Batteries and Lithium Ion Battery Products
6 directly or indirectly from Defendants and their co-conspirators have been deprived of the benefit of
7 free and open competition.

8 f. As a direct and proximate result of Defendants' unlawful conduct, California
9 Plaintiff and the members of the California Damages Class have been injured in their business and
10 property in that they paid more for Lithium Ion Battery Products than they otherwise would have
11 paid in the absence of Defendants' unlawful conduct. As a result of Defendants' violation of Section
12 16720 of the California Business and Professions Code, California Plaintiff and the California
13 Damages Class seek treble damages and their cost of suit, including a reasonable attorney's fee,
14 pursuant to section 16750(a) of the California Business and Professions Code.

15 502. Illinois: By reason of the foregoing, Defendants have violated the Illinois Antitrust
16 Act, Illinois Compiled Statutes, §§ 740 Ill. Comp. Stat. 10/1, *et seq.* Illinois Plaintiff on behalf of the
17 Illinois Damages Class alleges as follows:

18 a. Defendants' combination or conspiracy had the following effects: (1) price
19 competition for Lithium Ion Batteries was restrained, suppressed, and eliminated throughout Illinois;
20 (2) prices for Lithium Ion Batteries were raised, fixed, maintained and stabilized at artificially high
21 levels throughout Illinois; (3) Illinois Plaintiff and members of the Illinois Damages Class were
22 deprived of free and open competition; and (4) Illinois Plaintiff and members of the Illinois Damages
23 Class paid supra-competitive, artificially inflated prices for Lithium Ion Battery Products.

24 b. During the Class Period, Defendants' illegal conduct substantially affected
25 Illinois commerce.

26 c. As a direct and proximate result of Defendants' unlawful conduct, Illinois
27 Plaintiff and members of the Illinois Damages Class have been injured in their business and property
28 and are threatened with further injury.

1 d. By reason of the foregoing, Defendants entered into agreements in restraint of
2 trade in violation of Illinois Compiled Statutes, §§ 740 Ill. Comp. Stat. 10/1, *et seq.* Accordingly,
3 Illinois Plaintiff and the members of the Illinois Damages Class seek all forms of relief available
4 under Illinois Compiled Statutes, §§ 740 Ill. Comp. Stat. 10/1, *et seq.*

5 503. Kansas: By reason of the foregoing, Defendants have violated Kansas Statutes, §§ 50-
6 101, *et seq.* Kansas Plaintiff on behalf of the Kansas Damages Class alleges as follows:

7 a. Defendants' combination or conspiracy had the following effects: (1) price
8 competition for Lithium Ion Batteries was restrained, suppressed, and eliminated throughout Kansas;
9 (2) prices for Lithium Ion Batteries were raised, fixed, maintained and stabilized at artificially high
10 levels throughout Kansas; (3) Kansas Plaintiff and the Kansas Damages Class were deprived of free
11 and open competition; and (4) Kansas Plaintiff and the Kansas Damages Class paid supra-
12 competitive, artificially inflated prices for Lithium Ion Battery Products.

13 b. During the Class Period, Defendants' illegal conduct substantially affected
14 Kansas commerce.

15 c. As a direct and proximate result of Defendants' unlawful conduct, Kansas
16 Plaintiff and the Kansas Damages Class have been injured in their business and property and are
17 threatened with further injury.

18 d. By reason of the foregoing, Defendants have entered into agreements in
19 restraint of trade in violation of Kansas Statutes §§ 50-101, *et seq.* Accordingly, Kansas Plaintiff and
20 the Kansas Damages Class seek all forms of relief available under Kansas Statutes §§ 50-101, *et seq.*

21 504. Maine: By reason of the foregoing, Defendants have violated the Maine Revised
22 Statutes, 10 M.R.S. § 1101, *et seq.* Maine Plaintiff on behalf of the Maine Damages Class alleges as
23 follows:

24 a. Defendants' combination or conspiracy had the following effects: (1) price
25 competition for Lithium Ion Batteries was restrained, suppressed, and eliminated throughout Maine;
26 (2) prices for Lithium Ion Batteries were raised, fixed, maintained and stabilized at artificially high
27 levels throughout Maine; (3) Maine Plaintiff and the Maine Damages Class were deprived of free
28

1 and open competition; and (4) Maine Plaintiff and the Maine Damages Class paid supra-competitive,
2 artificially inflated prices for Lithium Ion Battery Products.

3 b. During the Class Period, Defendants' illegal conduct substantially affected
4 Maine commerce.

5 c. As a direct and proximate result of Defendants' unlawful conduct, Maine
6 Plaintiff and the Maine Damages Class have been injured in their business and property and are
7 threatened with further injury.

8 d. By reason of the foregoing, Defendants have entered into agreements in
9 restraint of trade in violation of Maine Revised Statutes 10, §§ 1101, *et seq.* Accordingly, Maine
10 Plaintiff and the Maine Damages Class seek all relief available under Maine Revised Statutes 10, §§
11 1101, *et seq.*

12 505. Michigan: By reason of the foregoing, Defendants have violated Michigan Compiled
13 Laws §§ 445.773, *et seq.* Michigan Plaintiff on behalf of the Michigan Damages Class alleges as
14 follows:

15 a. Defendants' combination or conspiracy had the following effects: (1) price
16 competition for Lithium Ion Batteries was restrained, suppressed, and eliminated throughout
17 Michigan; (2) prices for Lithium Ion Batteries were raised, fixed, maintained and stabilized at
18 artificially high levels throughout Michigan; (3) Michigan Plaintiff and the Michigan Damages Class
19 were deprived of free and open competition; and (4) Michigan Plaintiff and the Michigan Damages
20 Class paid supra-competitive, artificially inflated prices for Lithium Ion Battery Products.

21 b. During the Class Period, Defendants' illegal conduct substantially affected
22 Michigan commerce.

23 c. As a direct and proximate result of Defendants' unlawful conduct, Michigan
24 Plaintiff and the Michigan Damages Class have been injured in their business and property and are
25 threatened with further injury.

26 d. By reason of the foregoing, Defendants have entered into agreements in
27 restraint of trade in violation of Michigan Compiled Laws §§ 445.773, *et seq.* Accordingly, Michigan
28

1 Plaintiff and the Michigan Damages Class seek all relief available under Michigan Compiled Laws
2 §§ 445.73, *et seq.*

3 506. Minnesota: By reason of the foregoing, Defendants have violated Minnesota Statutes
4 §§ 325D.49, *et seq.* Minnesota Plaintiff on behalf of the Minnesota Damages Class alleges as
5 follows:

6 a. Defendants' combination or conspiracy had the following effects: (1) price
7 competition for Lithium Ion Batteries was restrained, suppressed, and eliminated throughout
8 Minnesota; (2) prices for Lithium Ion Batteries were raised, fixed, maintained and stabilized at
9 artificially high levels throughout Minnesota; (3) Minnesota Plaintiff and the Minnesota Damages
10 Class were deprived of free and open competition; and (4) Minnesota Plaintiff and the Minnesota
11 Damages Class paid supra-competitive, artificially inflated prices for Lithium Ion Battery Products.

12 b. During the Class Period, Defendants' illegal conduct substantially affected
13 Minnesota commerce.

14 c. As a direct and proximate result of Defendants' unlawful conduct, Minnesota
15 Plaintiff and the Minnesota Damages Class have been injured in their business and property and are
16 threatened with further injury.

17 d. By reason of the foregoing, Defendants have entered into agreements in
18 restraint of trade in violation of Minnesota Statutes §§ 325D.49, *et seq.* Accordingly, Minnesota
19 Plaintiff and the Minnesota Damages Class seek all relief available under Minnesota Statutes
20 §§ 325D.49, *et seq.*

21 507. Mississippi: By reason of the foregoing, Defendants have violated Mississippi Code
22 §§ 75-21-1, *et seq.* Mississippi Plaintiff on behalf of the Mississippi Damages Class alleges as
23 follows:

24 a. Defendants' combination or conspiracy had the following effects: (1) price
25 competition for Lithium Ion Batteries was restrained, suppressed, and eliminated throughout
26 Mississippi; (2) prices for Lithium Ion Batteries were raised, fixed, maintained and stabilized at
27 artificially high levels throughout Mississippi; (3) Mississippi Plaintiff and the Mississippi Damages
28

1 Class were deprived of free and open competition; and (4) Mississippi Plaintiff and the Mississippi
2 Damages Class paid supra-competitive, artificially inflated prices for Lithium Ion Battery Products.

3 b. During the Class Period, Defendants' illegal conduct substantially affected
4 Mississippi commerce.

5 c. As a direct and proximate result of Defendants' unlawful conduct, Mississippi
6 Plaintiff and the Mississippi Damages Class have been injured in their business and property and are
7 threatened with further injury.

8 d. By reason of the foregoing, Defendants have entered into agreements in
9 restraint of trade in violation of Mississippi Code §§ 75-21-1, *et seq.*

10 e. Accordingly, Mississippi Plaintiff and the Mississippi Damages Class seek all
11 relief available under Mississippi Code § 75-21-1, *et seq.*

12 508. Nebraska: By reason of the foregoing, Defendants have violated Nebraska Revised
13 Statutes §§ 59-801, *et seq.* Nebraska Plaintiff on behalf of the Nebraska Damages Class alleges as
14 follows:

15 a. Defendants' combination or conspiracy had the following effects: (1) price
16 competition for Lithium Ion Batteries was restrained, suppressed, and eliminated throughout
17 Nebraska; (2) prices for Lithium Ion Batteries were raised, fixed, maintained and stabilized at
18 artificially high levels throughout Nebraska; (3) Nebraska Plaintiff and the Nebraska Damages Class
19 were deprived of free and open competition; and (4) Nebraska Plaintiff and the Nebraska Damages
20 Class paid supra-competitive, artificially inflated prices for Lithium Ion Battery Products.

21 b. During the Class Period, Defendants' illegal conduct substantially affected
22 Nebraska commerce.

23 c. As a direct and proximate result of Defendants' unlawful conduct, Nebraska
24 Plaintiff and the Nebraska Damages Class have been injured in their business and property and are
25 threatened with further injury.

26 d. By reason of the foregoing, Defendants have entered into agreements in
27 restraint of trade in violation Nebraska Revised Statutes §§ 59-801, *et seq.* Accordingly, Nebraska
28

1 Plaintiff and the Nebraska Damages Class seek all relief available under Nebraska Revised Statutes
2 §§ 59-801, *et seq.*

3 509. Nevada: By reason of the foregoing, Defendants have violated Nevada Revised
4 Statutes §§ 598A.010, *et seq.* Nevada Plaintiff on behalf of the Nevada Damages Class alleges as
5 follows:

6 a. Defendants' combination or conspiracy had the following effects: (1) price
7 competition for Lithium Ion Batteries was restrained, suppressed, and eliminated throughout Nevada;
8 (2) prices for Lithium Ion Batteries were raised, fixed, maintained and stabilized at artificially high
9 levels throughout Nevada; (3) Nevada Plaintiff and the Nevada Damages Class were deprived of free
10 and open competition; and (4) Nevada Plaintiff and the Nevada Damages Class paid supra-
11 competitive, artificially inflated prices for Lithium Ion Battery Products.

12 b. During the Class Period, Defendants' illegal conduct substantially affected
13 Nevada commerce.

14 c. As a direct and proximate result of Defendants' unlawful conduct, Nevada
15 Plaintiff and the Nevada Damages Class have been injured in their business and property and are
16 threatened with further injury.

17 d. By reason of the foregoing, Defendants have entered into agreements in
18 restraint of trade in violation of Nevada Revised Statutes §§ 598A.010, *et seq.* Accordingly, Nevada
19 Plaintiff and the Nevada Damages Class seek all relief available under Nevada Revised Statutes §§
20 598A.010, *et seq.*

21 510. New York: By reason of the foregoing, Defendants have violated New York General
22 Business Laws §§ 340, *et seq.* New York Plaintiff on behalf of the New York Damages Class alleges
23 as follows:

24 a. Defendants' combination or conspiracy had the following effects: (1) price
25 competition for Lithium Ion Batteries was restrained, suppressed, and eliminated throughout New
26 York; (2) prices for Lithium Ion Batteries were raised, fixed, maintained and stabilized at artificially
27 high levels throughout New York; (3) New York Plaintiff and the New York Damages Class were
28

1 deprived of free and open competition; and (4) New York Plaintiff and the New York Damages
2 Class paid supra-competitive, artificially inflated prices for Lithium Ion Battery Products.

3 b. During the Class Period, Defendants' illegal conduct substantially affected
4 New York commerce.

5 c. As a direct and proximate result of Defendants' unlawful conduct, New York
6 Plaintiff and the New York Damages Class have been injured in their business and property and are
7 threatened with further injury.

8 d. By reason of the foregoing, Defendants have entered into agreements in
9 restraint of trade in violation of New York General Business Laws §§ 340, *et seq.* Accordingly, New
10 York Plaintiff and the New York Damages Class seek all relief available under New York General
11 Business Laws §§ 340, *et seq.*

12 511. Oregon: By reason of the foregoing, Defendants have violated Oregon Revised
13 Statutes §§ 646.705, *et seq.* Oregon Plaintiffs on behalf of the Oregon Damages Class allege as
14 follows:

15 a. Defendants' combination or conspiracy had the following effects: (1) price
16 competition for Lithium Ion Batteries was restrained, suppressed, and eliminated throughout Oregon;
17 (2) prices for Lithium Ion Batteries were raised, fixed, maintained and stabilized at artificially high
18 levels throughout Oregon; (3) Oregon Plaintiffs and the Oregon Damages Class were deprived of
19 free and open competition; and (4) Oregon Plaintiffs and the Oregon Damages Class paid supra-
20 competitive, artificially inflated prices for Lithium Ion Battery Products.

21 b. During the Class Period, Defendants' illegal conduct had a substantial effect
22 on Oregon commerce.

23 c. As a direct and proximate result of Defendants' unlawful conduct, Oregon
24 Plaintiffs and the Oregon Damages Class have been injured in their business and property and are
25 threatened with further injury.

26 d. By reason of the foregoing, Defendants have entered into agreements in
27 restraint of trade in violation of Oregon Revised Statutes §§ 646.705, *et seq.* Accordingly, Oregon
28

1 Plaintiffs and the Oregon Damages Class seek all relief available under Oregon Revised Statutes
2 §§ 646.705, *et seq.*

3 512. Tennessee: By reason of the foregoing, Defendants have violated Tennessee Code §§
4 47-25-101, *et seq.* Tennessee Plaintiff on behalf of the Tennessee Damages Class alleges as follows:

5 a. Defendants' combination or conspiracy had the following effects: (1) price
6 competition for Lithium Ion Batteries was restrained, suppressed, and eliminated throughout
7 Tennessee; (2) prices for Lithium Ion Batteries were raised, fixed, maintained and stabilized at
8 artificially high levels throughout Tennessee; (3) Tennessee Plaintiff and the Tennessee Damages
9 Class were deprived of free and open competition; and (4) Tennessee Plaintiff and the Tennessee
10 Damages Class paid supra-competitive, artificially inflated prices for Lithium Ion Battery Products.

11 b. During the Class Period, Defendants' illegal conduct had a substantial effect
12 on Tennessee commerce as products containing Lithium Ion Batteries were sold in Tennessee.

13 c. As a direct and proximate result of Defendants' unlawful conduct, Tennessee
14 Plaintiff and the Tennessee Damages Class have been injured in their business and property and are
15 threatened with further injury.

16 d. By reason of the foregoing, Defendants have entered into agreements in
17 restraint of trade in violation of Tennessee Code §§ 47-25-101, *et seq.* Accordingly, Tennessee
18 Plaintiff and the Tennessee Damages Class seek all relief available under Tennessee Code §§ 47-25-
19 101, *et seq.*

20 513. West Virginia: By reason of the foregoing, Defendants have violated West Virginia
21 Code §§ 47-18-1, *et seq.* West Virginia Plaintiff on behalf of the West Virginia Damages Class
22 alleges as follows:

23 a. Defendants' combination or conspiracy had the following effects: (1) price
24 competition for Lithium Ion Batteries was restrained, suppressed, and eliminated throughout West
25 Virginia; (2) prices for Lithium Ion Batteries were raised, fixed, maintained and stabilized at
26 artificially high levels throughout West Virginia; (3) West Virginia Plaintiff and the West Virginia
27 Damages Class were deprived of free and open competition; and (4) West Virginia Plaintiff and the
28

1 West Virginia Damages Class paid supra-competitive, artificially inflated prices for Lithium Ion
2 Battery Products.

3 b. During the Class Period, Defendants' illegal conduct had a substantial effect
4 on West Virginia commerce.

5 c. As a direct and proximate result of Defendants' unlawful conduct, West
6 Virginia Plaintiff and the West Virginia Damages Class have been injured in their business and
7 property and are threatened with further injury.

8 d. By reason of the foregoing, Defendants have entered into agreements in
9 restraint of trade in violation of West Virginia Code §§ 47-18-1, *et seq.* Accordingly, West Virginia
10 Plaintiff and the West Virginia Damages Class seek all relief available under West Virginia Code §§
11 47-18-1, *et seq.*

12 514. Wisconsin: By reason of the foregoing, Defendants have violated Wisconsin Statutes
13 §§ 133.01, *et seq.* Wisconsin Plaintiff on behalf of the Wisconsin Damages Class alleges as follows:

14 a. Defendants' combination or conspiracy had the following effects: (1) price
15 competition for Lithium Ion Batteries was restrained, suppressed, and eliminated throughout
16 Wisconsin; (2) prices for Lithium Ion Batteries were raised, fixed, maintained and stabilized at
17 artificially high levels throughout Wisconsin; (3) Wisconsin Plaintiff and the Wisconsin Damages
18 Class were deprived of free and open competition; and (4) Wisconsin Plaintiff and the Wisconsin
19 Damages Class paid supra-competitive, artificially inflated prices for Lithium Ion Battery Products.

20 b. During the Class Period, Defendants' illegal conduct had a substantial effect
21 on Wisconsin commerce.

22 c. As a direct and proximate result of Defendants' unlawful conduct, Wisconsin
23 Plaintiff and the Wisconsin Damages Class have been injured in their business and property and are
24 threatened with further injury.

25 d. By reason of the foregoing, Defendants have entered into agreements in
26 restraint of trade in violation of Wisconsin Statutes §§ 133.01, *et seq.* Accordingly, Wisconsin
27 Plaintiff and the Wisconsin Damages Class seek all relief available under Wisconsin Statutes
28 §§ 133.01, *et seq.*

FIFTH CLAIM FOR RELIEF

**VIOLATION OF STATE CONSUMER PROTECTION
AND UNFAIR COMPETITION LAWS)
(On Behalf of All Plaintiffs against All Defendants)**

1
2
3
4
5
6
7
8
9
10
11
12
13
14
15
16
17
18
19
20
21
22
23
24
25
26
27
28

515. Plaintiffs incorporate by reference the allegations in the above paragraphs as if fully set forth herein.

516. In the event that the Court does not apply California law on a nationwide basis, Plaintiffs allege the following violations of state consumer protection and unfair competition laws in the alternative.

517. Defendants engaged in unfair competition or unfair, unconscionable, deceptive or fraudulent acts or practices in violation of the state consumer protection and unfair competition statutes listed below.

518. California: By reason of the foregoing, Defendants have violated California's Unfair Competition Law, Cal. Bus. & Prof. Code §§ 17200, *et seq.* California Plaintiff on behalf of the California Damages Class alleges as follows:

a. Defendants committed acts of unfair competition, as defined by section 17200, *et seq.*, by engaging in a conspiracy to fix and stabilize the price of Lithium Ion Batteries as described above.

b. The acts, omissions, misrepresentations, practices and non-disclosures of Defendants, as described above, constitute a common and continuing course of conduct of unfair competition by means of unfair, unlawful and/or fraudulent business acts or practices with the meaning of section 17200, *et seq.*, including, but not limited to (1) violation of Section 1 of the Sherman Act; (2) violation of the Cartwright Act.

c. Defendants' acts, omissions, misrepresentations, practices and nondisclosures are unfair, unconscionable, unlawful and/or fraudulent independently of whether they constitute a violation of the Sherman Act or the Cartwright Act.

d. Defendants' acts or practices are fraudulent or deceptive within the meaning of section 17200, *et seq.*

1 e. Defendants' conduct was carried out, effectuated, and perfected within the
2 State of California. Defendants maintained offices in California where their employees engaged in
3 communications, meetings and other activities in furtherance of Defendants' conspiracy.

4 f. By reason of the foregoing, California Plaintiff and the California Damages
5 Class are entitled to full restitution and/or disgorgement of all revenues, earnings, profits,
6 compensation, and benefits that may have been obtained by Defendants as result of such business
7 acts and practices described above.

8 519. Florida: By reason of the foregoing, Defendants have violated the Florida Deceptive
9 and Unfair Trade Practices Act, Fla. Stat. §§ 501.201, *et seq.* Florida Plaintiff on behalf of the
10 Florida Damages Class alleges as follows:

11 a. Defendants' unlawful conduct had the following effects: (1) price
12 competition for Lithium Ion Batteries and Lithium Ion Battery Products was restrained, suppressed,
13 and eliminated throughout Florida; (2) prices for Lithium Ion Batteries and Lithium Ion Battery
14 Products were raised, fixed, maintained, and stabilized at artificially high levels throughout Florida;
15 (3) Florida Plaintiff and the Florida Damages Class were deprived of free and open competition; and
16 (4) Florida Plaintiff and the Florida Damages Class paid supra-competitive, artificially inflated
17 prices for Lithium Ion Batteries and Lithium Ion Battery Products.

18 b. During the Class Period, Defendants' illegal conduct substantially affected
19 Florida commerce and consumers.

20 c. As a direct and proximate result of Defendants' unlawful conduct, Florida
21 Plaintiff and the Florida Damages Class have been injured and are threatened with further injury.

22 d. Defendants have engaged in unfair competition or unfair or deceptive acts or
23 practices in violation of Fla. Stat. §§ 501.201, *et seq.*, and, accordingly, Florida Plaintiff and the
24 Florida Damages Class seek all relief available under that statute.

25 520. Massachusetts: By reason of the foregoing, Defendants have violated the
26 Massachusetts Consumer and Business Protection Act, M.G.L. c. 93A, § 1, *et seq.* Massachusetts
27 Plaintiff on behalf of the Massachusetts Damages Class alleges as follows:
28

1 a. Defendants were engaged in trade or commerce as defined by M.G.L. c. 93A,
2 § 1.

3 b. Defendants agreed to, and did in fact, act in restraint of trade or commerce in
4 a market which includes Massachusetts, by affecting, fixing, controlling and/or maintaining at
5 artificial and noncompetitive levels, the prices at which Lithium Ion Batteries and Lithium Ion
6 Battery Products were sold, distributed, or obtained in Massachusetts and took efforts to conceal
7 their agreements from the Massachusetts Plaintiffs and members of the Massachusetts Damages
8 Class.

9 c. Defendants' unlawful conduct had the following effects: (1) price
10 competition for Lithium Ion Batteries and Lithium Ion Battery Products was restrained, suppressed,
11 and eliminated throughout Massachusetts; (2) the prices of Lithium Ion Batteries and Lithium Ion
12 Battery Products were raised, fixed, maintained, and stabilized at artificially high levels throughout
13 Massachusetts; (3) Massachusetts Plaintiffs and members of the Massachusetts Damages Class were
14 deprived of free and open competition; and (4) Massachusetts Plaintiffs and members of the
15 Massachusetts Damages Class paid supra-competitive, artificially inflated prices for Lithium Ion
16 Batteries and Lithium Ion Battery Products.

17 d. As a direct and proximate result of Defendants' unlawful conduct,
18 Massachusetts Plaintiffs and members of the Massachusetts Damages Class were injured and are
19 threatened with further injury.

20 e. Each of the Defendants or their representatives have been served with a
21 demand letter in accordance with M.G.L. c. 93A, § 1, or such service of a demand letter was
22 unnecessary due to the defendant not maintaining a place of business within the Commonwealth of
23 Massachusetts or not keeping assets within the Commonwealth. More than thirty days has passed
24 since such demand letters were served, and each Defendant served has failed to make a reasonable
25 settlement offer.

26 f. By reason of the foregoing, Defendants engaged in unfair competition and
27 unfair or deceptive acts or practices, in violation of M.G.L. c. 93A, § 2. Defendants' and their co-

28

1 conspirators' violations of Chapter 93A were knowing or willful, entitling the Massachusetts
2 Plaintiff and the Massachusetts Damages Class to multiple damages.

3 521. Missouri: By reason of the foregoing, Defendants have violated Missouri's
4 Merchandising Practices Act, specifically Mo. Rev. Stat. § 407.020. Missouri Plaintiff on behalf of
5 the Missouri Damages Class alleges as follows:

6 a. Missouri Plaintiff and members of the Missouri Damages Class purchased
7 Lithium Ion Batteries and/or Lithium Ion Battery Products for personal, family, or household
8 purposes.

9 b. Defendants engaged in the conduct described herein in connection with the
10 sale of Lithium Ion Batteries and Lithium Ion Battery Products in trade or commerce in a market
11 that includes Missouri.

12 c. Defendants agreed to, and did in fact affect, fix, control, and/or maintain, at
13 artificial and non-competitive levels, the prices at which Lithium Ion Batteries and Lithium Ion
14 Battery Products were sold, distributed, or obtained in Missouri, which conduct constituted unfair
15 practices in that it was unlawful under federal and state law, violated public policy, was unethical,
16 oppressive and unscrupulous, and caused substantial injury to Missouri Plaintiff and the members of
17 the Missouri Damages Class.

18 d. Defendants concealed, suppressed, and omitted to disclose material facts to
19 Missouri Plaintiff and the members of the Missouri Damages Class concerning Defendants'
20 unlawful activities and artificially inflated prices for Lithium Ion Batteries and Lithium Ion Battery
21 Products. The concealed, suppressed, and omitted facts would have been important to Missouri
22 Plaintiff and the members of the Missouri Damages Class as they related to the cost of Lithium Ion
23 Batteries and Lithium Ion Battery Products that they purchased.

24 e. Defendants misrepresented the real cause of price increases and/or the
25 absence of price reductions in Lithium Ion Batteries and Lithium Ion Battery Products by making
26 public statements that were not in accord with the facts.

27 f. Defendants' statements and conduct concerning the price of Lithium Ion
28 Batteries and Lithium Ion Battery Products were deceptive as they had the tendency or capacity to

1 mislead Missouri Plaintiff and the members of the Missouri Damages Class to believe that they
2 were purchasing Lithium Ion Batteries and Lithium Ion Battery Products at prices established by a
3 free and fair market. Defendants' unlawful conduct had the following effects: (1) Lithium Ion
4 Batteries and Lithium Ion Battery Products price competition was restrained, suppressed, and
5 eliminated throughout Missouri; (2) Lithium Ion Batteries and Lithium Ion Battery Products prices
6 were raised, fixed, maintained, and stabilized at artificially high levels throughout Missouri; (3)
7 Missouri Plaintiff and members of the Missouri Damages Class were deprived of free and open
8 competition; and (4) Missouri Plaintiff and members of the Missouri Damages Class paid supra-
9 competitive, artificially inflated prices for Lithium Ion Batteries and Lithium Ion Battery Products.

10 g. The foregoing acts and practices constituted unlawful practices in violation of
11 the Missouri Merchandising Practices Act.

12 h. As a direct and proximate result of the above-described unlawful practices,
13 Missouri Plaintiff and members of the Missouri Damages Class suffered ascertainable loss of
14 money or property.

15 i. Accordingly, Missouri Plaintiff and members of the Missouri Damages Class
16 seek all relief available under Missouri's Merchandising Practices Act, specifically Mo. Rev. Stat. §
17 407.020, which prohibits "the act, use or employment by any person of any deception, fraud, false
18 pretense, false promise, misrepresentation, unfair practice or the concealment, suppression, or
19 omission of any material fact in connection with the sale or advertisement of any merchandise in
20 trade or commerce," as further interpreted by the Missouri Code of State Regulations, 15 CSR 60-
21 7.010, *et seq.*, 15 CSR 60-8.010, *et seq.*, and 15 CSR 60-9.010, *et seq.*, and Mo. Rev. Stat. §
22 407.025, which provides for the relief sought in this count.

23 522. Nebraska: By reason of the foregoing, Defendants have violated Nebraska's
24 Consumer Protection Act, Neb. Rev. Stat. §§ 59-1601, *et seq.* Nebraska Plaintiff on behalf of the
25 Nebraska Damages Class alleges as follows:

26 a. Defendants' unlawful conduct had the following effects: (1) Lithium Ion
27 Batteries and Lithium Ion Battery Products price competition was restrained, suppressed, and
28 eliminated throughout Nebraska; (2) Lithium Ion Batteries and Lithium Ion Battery Products prices

1 were raised, fixed, maintained, and stabilized at artificially high levels throughout Nebraska;
2 (3) Nebraska Plaintiff and the Nebraska Damages Class were deprived of free and open
3 competition; and (4) Nebraska Plaintiff and the Nebraska Damages Class paid supra-competitive,
4 artificially inflated prices for Lithium Ion Batteries and Lithium Ion Battery Products.

5 b. During the Class Period, Defendants' illegal conduct substantially affected
6 Nebraska commerce and consumers.

7 c. As a direct and proximate result of Defendants' unlawful conduct, Nebraska
8 Plaintiff and the Nebraska Damages Class have been injured and are threatened with further injury.

9 d. Defendants' actions and conspiracy have had a substantial impact on the
10 public interests of Nebraska and its residents.

11 e. Defendants have engaged in unfair competition or unfair or deceptive acts or
12 practices in violation of Nebraska's Consumer Protection Act, Neb. Rev. Stat. §§ 59-1601, *et seq.*
13 and, accordingly, Nebraska Plaintiff and the Nebraska Damages Class seek all relief available under
14 that statute.

15 523. New York: By reason of the foregoing, Defendants have violated New York's
16 General Business Law, N.Y. Gen. Bus. Law § 349, *et seq.* New York Plaintiff on behalf of the New
17 York Damages Class alleges as follows:

18 a. Defendants agreed to, and did in fact, act in restraint of trade or commerce by
19 affecting, fixing, controlling and/or maintaining, at artificial and noncompetitive levels, the prices at
20 which Lithium Ion Batteries and Lithium Ion Battery Products were sold, distributed or obtained in
21 New York and took efforts to conceal their agreements from New York Plaintiff and the New York
22 Damages Class.

23 b. The conduct of the Defendants described herein constitutes consumer-
24 oriented deceptive acts or practices within the meaning of N.Y. Gen. Bus. Law § 349, which
25 resulted in consumer injury and broad adverse impact on the public at large, and harmed the public
26 interest of New York State in an honest marketplace in which economic activity is conducted in a
27 competitive manner.

1 c. Defendants made certain statements about Lithium Ion Batteries and Lithium
2 Ion Battery Products that they knew would be seen by New York residents and these statements
3 either omitted material information that rendered the statements they made materially misleading or
4 affirmatively misrepresented the real cause of price increases for Lithium Ion Batteries and Lithium
5 Ion Battery Products.

6 d. Defendants' unlawful conduct had the following effects: (1) Lithium Ion
7 Batteries and Lithium Ion Battery Products price competition was restrained, suppressed, and
8 eliminated throughout New York; (2) Lithium Ion Batteries and Lithium Ion Battery Products prices
9 were raised, fixed, maintained, and stabilized at artificially high levels throughout New York; (3)
10 New York Plaintiff and the New York Damages Class were deprived of free and open competition;
11 and (4) New York Plaintiff and the New York Damages Class paid supra-competitive, artificially
12 inflated prices for Lithium Ion Batteries and Lithium Ion Battery Products.

13 e. During the Class Period, Defendants' illegal conduct substantially affected
14 New York commerce and consumers.

15 f. During the Class Period, each of the Defendants named herein, directly, or
16 indirectly and through affiliates they dominated and controlled, manufactured, sold and/or
17 distributed Lithium Ion Batteries and Lithium Ion Battery Products in New York.

18 g. New York Plaintiff and the New York Damages Class seek actual damages
19 for their injuries caused by these violations in an amount to be determined at trial and are threatened
20 with further injury. Without prejudice to their contention that Defendants' unlawful conduct was
21 willful and knowing, New York Plaintiff and the New York Damages Class do not seek in this
22 action to have those damages trebled pursuant to N.Y. Gen. Bus. Law § 349(h).

23

24

PRAYER FOR RELIEF

25

WHEREFORE, Plaintiffs and Class members pray for relief as set forth below:

26

A. Certification of the action as a class action pursuant to Federal Rule of Civil

27

Procedure 23, and appointment of Plaintiffs as Class Representatives and their counsel of record as

28

Class Counsel;

1 B. A declaration that Defendants' conduct constituted an unlawful restraint of trade in
2 violation of the federal and state statutes alleged herein and that Defendants are liable for the conduct
3 or damage inflicted by any other co-conspirator.

4 C. Restitution and/or damages to Class members for their purchases of Lithium Ion
5 Batteries and Lithium Ion Battery Products at inflated prices;

6 D. Actual damages, statutory damages, punitive or treble damages, and such other relief
7 as provided by the statutes cited herein;

8 E. Pre-judgment and post-judgment interest on such monetary relief;

9 F. Equitable relief in the form of restitution and/or disgorgement of all unlawful or
10 illegal profits received by Defendants as a result of the anticompetitive conduct alleged herein;

11 G. An injunction against Defendants, their affiliates, successors, transferees, assignees,
12 and other officers, directors, partners, agents and employees thereof, and all other persons acting or
13 claiming to act on their behalf or in concert with them from in any manner continuing, maintaining,
14 or renewing the conduct, contract, conspiracy, or combination alleged herein, or from entering into
15 any other contract, conspiracy, or combination having a similar purpose or effect, and from adopting
16 or following any practice, plan, program or device having a similar purpose or effect

17 H. The costs of bringing this suit, including reasonable attorneys' fees; and

18 I. All other relief to which Plaintiffs and Class members may be entitled at law or in
19 equity.

20 **DEMAND FOR JURY TRIAL**

21 Plaintiffs on behalf of themselves and all others similarly situated hereby request a jury trial
22 on any and all claims so triable.

23 DATED: March 18, 2016

HAGENS BERMAN SOBOL SHAPIRO LLP

25 By: /s/ Steve W. Berman
26 STEVE W. BERMAN

27 Jeff D. Friedman (173886)
28 Shana Scarlett (217895)
715 Hearst Avenue, Suite 202
Berkeley, CA 94710

1
2
3
4
5
6
7
8
9
10
11
12
13
14
15
16
17
18
19
20
21
22
23
24
25
26
27
28

Telephone: (510) 725-3000
Facsimile: (510) 725-3001
steve@hbsslaw.com
jefff@hbsslaw.com
shanas@hbsslaw.com

DATED: March 18, 2016

COTCHETT, PITRE & McCARTHY, LLP

By: /s/ Steven N. Williams
 STEVEN N. WILLIAMS

Joseph W. Cotchett (36324)
Steven N. Williams (175489)
Demetrius X. Lambrinos (246027)
Joyce Chang (300780)
COTCHETT, PITRE & McCARTHY, LLP
840 Malcolm Road
Burlingame, CA 94010
Telephone: (650) 697-6000
Facsimile: (650) 697-0577
jcotchett@cpmlegal.com
swilliams@cpmlegal.com
dlambrinos@cpmlegal.com
jchang@cpmlegal.com

DATED: March 18, 2016

LIEFF CABRASER HEIMANN & BERNSTEIN, LLP

By: /s/ Eric B. Fastiff
 ERIC B. FASTIFF

Elizabeth J. Cabraser (083151)
Richard M. Heimann (63607)
Brendan P. Glackin (199643)
Dean M. Harvey (250298)
Lin Y. Chan (255027)
275 Battery Street, 29th Floor
San Francisco, CA 94111-3339
Telephone: (415) 956-1000
Facsimile: (415) 956-1008
ecabraser@lchb.com
rheimann@lchb.com
efastiff@lchb.com
bglackin@lchb.com
dharvey@lchb.com
lchan@lchb.com

***Indirect Purchaser Plaintiffs
Interim Co-Lead Class Counsel***

ATTESTATION

Pursuant to Civil Local Rule 5-1(i)(3), the filer of this document attests that concurrence in the filing of this document has been obtained from the other signatories above.

DATED: March 18, 2016

By /s/ Steve W. Berman
STEVE W. BERMAN

1
2
3
4
5
6
7
8
9
10
11
12
13
14
15
16
17
18
19
20
21
22
23
24
25
26
27
28